CONCRETE MATERIALS AND TESTING
5-694.100**5-694.101 GENERAL REQUIREMENTS**

The Specifications contain requirements for all concrete materials. Inspect all materials used in the construction of concrete work at their source, on the job, or both. The Engineers and Inspectors must inspect all materials to assure they meet all requirements prior to incorporation into the work. Attention is called to Mn/DOT Standard Specifications for Construction References 1601 through 1607 and the sections of Division III (3000 Series) for the materials used.

5-694.110 CEMENTITIOUS MATERIALS

Cementitious material includes: portland cement, blended cements, ground granulated blast furnace slag, fly ash, silica fume, metakaolins and other materials having cementitious properties. Only portland cement, blended portland cement, ground granulated blast furnace slag, and fly ash are addressed in this section.

Cementitious material composed of portland cement, blended cements, ground granulated blast furnace slag, and fly ash are acceptable providing the material complies with 3101, 3102, 3103, 3115 and the substitution limits of 2461.3D. Only certified cementitious sources are allowed.

Do not use material of questionable quality (old, contaminated, wet, etc.) until approval is received from the Mn/DOT Office of Materials Laboratory.

Specification 1601 prohibits using more than one source of material without permission from the Engineer. It is generally preferable that for finished surfaces, such as bridge decks, walks and medians, as well as for retaining walls, a single brand is used throughout if possible. For portions of a structure below grade, limitations on brands for control are not necessary.

A list of certified cementitious material sources are available on the Mn/DOT Concrete Engineering website at www.mrr.dot.state.mn.us/pavement/concrete/products.asp.

A. Portland Cement

Portland cement is made from four basic compounds, tricalcium silicate (C_3S), dicalcium silicate (C_2S), tricalcium aluminate (C_3A), and tetracalcium aluminoferrite (C_4AF). The cements used in Minnesota are made either from limestone and clay, limestone and shale, or limestone and slag. The manufacturing process known as the dry process is the most widely used at present. This consists of grinding the individual raw materials and feeding at controlled amounts into a rotary kiln and burning until they fuse into small lumps or balls called clinkers. In the wet process, a slurry of the blend is fed into the rotary kiln. The clinkers are cooled and then ground in two operations. Between the first and the final grind, a quantity of gypsum (usually 2 to 3% by mass (weight) of cement) is added to regulate the setting properties of the cement.

Cement companies make various other types of cement such as High-Early, Air-Entraining, White Portland, Low Heat, and Sulfate Resisting Cements on special order. These are not normally used in Agency work.

B. Blended Cements

These blended cements are composed of one of five classes of hydraulic cement for general and special applications, using slag, fly ash or other pozzolan with portland cement, or portland cement clinker with slag. Ternary blends are not allowed without the approval of the Mn/DOT Concrete Engineer.

C. Ground Granulated Blast Furnace Slag (GGBFS)

In the blast furnace, magnetic iron ore (Fe_3O_4) and haematic iron ore (Fe_2O_3) are fed along with limestone into a high temperature chamber containing coke. Coke is partially oxidized to carbon monoxide, which reduces the ores to iron. The other product that floats over the molten iron due to its relative lightness is called slag. Slag is composed of calcium oxide (CaO), silica (SiO_2) and alumina (Al_2O_3). Slag is pulverized into a fine powder called ground granulated blast furnace slag and is used in this form as a cementitious component of concrete.

D. Fly Ash

Fly ash is the most widely used pozzolan in concrete. It is a fine residue resembling cement that is a by-product of burning coal in an electric power generating plant. Depending on the chemical consistency of the coal source, the material is identified as Class C (self-cementing) or Class F (non-cementing) fly ash.

5-694.111 CEMENTITIOUS MATERIAL HANDLING

The principal consideration in all operations involving the handling and sorting of cementitious material is to avoid damage or contamination of the product prior to its incorporation in the work.

Store cementitious material indefinitely if it is kept dry. Cement is usually improved and made more stable by a period of storage immediately subsequent to its manufacture since this permits stabilization of the free lime present in the freshly ground material.

Cementitious material is very susceptible to damage by contact with water or exposure to a moist atmosphere. When stored under such conditions for even comparatively short periods, cement takes up moisture and hydrates, making it unfit for use. Paper bags are somewhat resistant to atmospheric moisture, but do not provide adequate protection for long periods of storage. Material stored in bulk is less damaged by atmospheric moisture because the ratio of exposed surface to volume is much smaller than in sacked product. It is very important that lumps are screened out before use.

When bulk cementitious material is batched on the job by mass (weight), it is imperative that the specified amount is placed in each batch. This includes not only the accurate measurement, but also the prevention of loss of cementitious material during batching and in transit to the mixer.

On paving projects, Specification 2301.3F2 requires cut-offs for all cementitious materials. Make sure all shipments are received with seals intact. Make arrangements with the Contractor to document shipments received when the Agency is not present.

Make positive cementitious material cut-offs after the use of approximately 250 metric tons (500,000 pounds) and again prior to the use of 1000 metric tons (2 million pounds). Thereafter, a cementitious material cut-off is made at least every 1500 metric tons (3 million pounds) or once a week, whichever provides the longest time interval between cut-offs. The cementitious material cut-off is made at any time during the day. In making the cut-off, the Agency must know the exact amount of cementitious materials delivered to the plant. This quantity is determined from the invoices as specified in 2301.3F2.

An estimate of the amount of cementitious material used to date is made at the completion of the work each day and is determined from the amounts placed into the storage bins and silos, minus the amounts remaining in them. This estimate is compared with the total amount used based on the batch tickets.

The data for cementitious material received, unloaded, and used each day is recorded on the *Cement Record* (Form 2157). See Figure A 5-694.740 (1–3).

If using sacked material, the Inspector should assure that the entire contents of the bags are placed in the batch. Workers are often careless in this respect, and often leave several kilograms (pounds) in a bag. Workers should tie empty bags into bundles of 50 during each pour so that they may readily check the amount used. After counting the empty bags, remove them from the mixing site before the next pour begins.

5-694.112

CEMENTITIOUS MATERIAL INSPECTION

Give all cementitious material some form of visual inspection prior to use. For certified cementitious materials, inspection and testing at the source is required for compliance. See the Schedule of Materials Control for appropriate testing rates for the project.

Sampling occurs at the ready-mix or paving batch plant and is submitted to the Mn/DOT Office of Materials Laboratory for testing. Always take a sample when the condition of the cement is suspicious. No cementitious material is accepted at the project unless it is sealed and the seal is intact. The Producer/Contractor must either re-weigh or return to the shipping point transporters if they are without seals or have damaged seals.

When requested by the District Materials Engineer, the Ready-Mix Producer is required to obtain samples of cementitious materials for subsequent testing by the Agency. The samples shall weigh approximately 2 kg (5 lb.) and the Producer shall place them in an Agency provided container, sealed to prevent contamination. The Ready-Mix Producer shall identify the samples with a copy of the rail or transport invoice that identifies the brand, mill location and date sampled, and retain for the Agency Plant Monitor. The Agency Plant Monitor shall watch the material sampling process whenever possible.

The Producer/Contractor must handle and store cements shipped in paper bags (sacks) in a manner that will prevent the bags and cement from picking up moisture. Reject any sacks that take on moisture resulting in lumpy cement.

A *Cement Sample Identification Card* (Form 24300), Figure A 5-694.752 must accompany each sample.

5-694.113 CEMENTITIOUS MATERIAL COLOR

It is recognized that the color of a concrete surface is affected by other factors in addition to the color of the cementitious material. These may include water content, method and time of finishing, cement content, conditions of forms (in the case of formed surfaces), fly ash, and possibly others. Therefore, to ensure uniformity of concrete color, where it is considered important, take special care to assure all conditions, as well as the cementitious material color, are not modified.

5-694.114 CEMENT, GROUND GRANULATED BLAST FURNACE SLAG, AND BLENDED CEMENT CERTIFICATION

A list of certified cement and GGBFS sources are available on the Mn/DOT Concrete Engineering Unit website at www.mrr.dot.state.mn.us/pavement/concrete/products.asp.

I. General

Mn/DOT will only accept cementitious materials from certified sources.

Certification of any type of portland cement, blended cement, or GGBFS is based on testing of samples at the manufacturing plant, the distribution terminal, or at the port of entry with comparison sampling by Mn/DOT.

Only fly ash and GGBFS from certified sources are allowed for use in the manufacturing of blended cements. The Supplier shall provide proper documentation regarding each shipment of fly ash or GGBFS. See 5-694.116 for Fly Ash Certification. In manufacturing blended cement, the alkali content of the clinker shall not exceed the company's quality control criteria used for regular Type I cement. If the fly ash or GGBFS is blended or inter-ground with the cement, the cement shall comply with the Specifications and the requirements stated in this procedure.

Mixing of portland cement, blended cements, or GGBFS from different sources or of different types in one storage bin or silo is NOT PERMITTED.

The Supplier shall empty cement storage bins at ready-mix plants, batch plants, and pre-cast production plants, as far as practicable, prior to refilling from a different source. The Supplier shall store and dispense blended cement from separate storage bins.

The system for managing the documentation of the inspection of cementitious material was developed with four main objectives.

1. Mn/DOT projects must receive cementitious materials from certified sources only.
2. The certified source shall have a Mill Test Report Program that is approved by Mn/DOT to verify the quality of the cementitious material. The program must have an adequate testing schedule using standard procedures. As strength is a major factor in a uniform quality control program, Mn/DOT requires regular cube strength test results to evaluate trends in the cementitious materials.
3. Quality control testing is done by the Producer to assure that the material meets certain standards, whereas the owner does acceptance or verification testing. Therefore, the Agency may check cementitious material arriving at a ready-mix, batch, or pre-cast production plant for project verification by the construction project personnel so that unsuitable cementitious materials are not incorporated into projects.
4. Timely record keeping provides the ability to certify the product at the manufacturing plant or the distribution terminal, then track the product from the point of certification to the ready-mix plant, batch plant or pre-cast production plant. To make this system work, the manufacturer, distributor, and concrete producer must maintain records of dates that the product is manufactured, dates the product is shipped and received at various locations, and a Mill Test Report that corresponds to the quantity shipped.

Final acceptance is based upon the use of cementitious material from certified sources and upon satisfactory test results from field verification samples from the cementitious material at the time of incorporation into the concrete.

II. Certification Procedures

Cement specifications and testing shall comply with Specification 3101, AASHTO M 85, and ASTM C 150.

Ground granulated blast furnace slag (GGBFS) shall comply with Specification 3102, AASHTO M 302, and ASTM C 989.

Blended cements shall comply with Specification 3103, AASHTO M 240, ASTM C 595 and ASTM C 1157.

Acceptance is judged on the basis of time of set, false set, fineness, soundness, air content of the mortar, chemical analysis, and compressive strength. The slag activity index is also required for GGBFS.

Mn/DOT may require additional testing if these tests do not continuously meet the requirements. Mn/DOT may also require additional testing of the product prior to shipment due to special considerations on that project. When required, special testing provisions are stated in the Contract documentation for the project.

A. Cement, Ground Granulated Blast Furnace Slag, and Blended Cement Specifications and Testing

<u>AASHTO</u>	<u>ASTM</u>	<u>TEST</u>
T 106	C 109	Test Method for Compressive Strength of Hydraulic Cement Mortar
T 107	C 151	Test Method for Autoclave Expansion of Portland Cement
T 137	C 185	Test Method for Air Content of Hydraulic Cement Mortar
T 129	C 187	Test Method for Normal Consistency of Hydraulic Cement
T 131	C 191	Test Method for Time of Setting of Hydraulic Cement by Vicat Needle
T 153	C 204	Test Method for Fineness of Hydraulic Cement by Air Permeability Apparatus
T 154	C 266	Test Method for Time of Setting of Hydraulic Cement Paste by Gillmore Needles

B. Approved Laboratory

A laboratory is considered approved if it is properly equipped and staffed to perform the tests required for an acceptable quality control program. The Laboratory must participate in the Cement and Concrete Reference Laboratory (CCRL) or other program approved by the Mn/DOT Concrete Engineering Unit. A laboratory certification program is required.

C. Mill Test Report Program

The cement manufacturing plant or cement distribution terminal (certified source) shall submit to the Mn/DOT Concrete Engineer a copy of the proposed Mill Test Report Program. This program is submitted for approval, prior to certification, in writing to:

Mn/DOT Concrete Engineer
 Mn/DOT Office of Materials
 1400 Gervais Avenue
 Maplewood, MN 55109

The Mill Test Report Program shall outline, as a minimum, the following:

- Sampling Procedures
- Testing Procedures
- Quantity of Cementitious for Mill Test
- Statement on Failing Test Procedures
- Proof of CCRL Laboratory participation or Mn/DOT Laboratory Approval
- The proposed (Mn/DOT - Certified Source) Companion Testing rate
- Laboratory Name and Location
- Source of GGBFS and Blast Furnace Plant Location

Address any variations from Mn/DOT Standard Specifications 3101, 3102, 3103, AASHTO, ASTM, or other standard methods or procedures.

The following minimum testing rates and procedures shall apply at the certified source:

1. Obtain a 2 kg (5 lb.) grab sample representing not more than 400 metric tons (tons) at the manufacturing plant or distribution terminal.
2. Obtain 1 composite sample representing not more than 4800 metric tons (tons) at the manufacturing plant or at the distribution center representing a given Mill Test Report to include, but not limited to soundness, air content, fineness, time of set, cube strength, and chemical analysis.

Make all certified source Mill Test Reports available for study by Mn/DOT personnel for at least 3 years after testing of the cement represented is completed. The Agency may require copies of these reports at any time.

D. ASTM C 917 Sampling and Documentation

The Supplier shall use an ongoing compressive strength sampling program for uniformity and take and test samples at the rate and by the procedures outlined in ASTM C 917.

The Supplier shall electronically furnish the Agency with a tabular report as outlined in ASTM C 917. Submit the report quarterly via email to MaterialsLab@dot.state.mn.us to the attention of the Mn/DOT Concrete Engineer.

E. Companion Sampling and Testing Program

The certified source and Mn/DOT shall agree on a rate and procedure for sampling and shipping a companion sample to the Mn/DOT Office of Materials Laboratory for comparison testing. The comparison sample is obtained at a minimum rate of once per month for every month of production or one sample per shipment, whichever is less.

At the manufacturing plant, port of entry, or distribution terminal, the sample for comparison testing is taken by host State personnel (if available) or plant personnel at the time of manufacture or time of discharge. Take samples in accordance with AASHTO T 127 or ASTM C 183 and split into two samples. Test one portion by an approved laboratory as outlined in section B and ship the other portion (comparison sample), at least 10 kg (20 lb.) in size, to:

Mn/DOT Office of Materials
Attn: Cementitious Comparison Sample
1400 Gervais Avenue
Maplewood, MN 55109

Ship the comparison sample to Mn/DOT within 10 days of the sample date and label as to:

- Date sampled
- Comparison sample number and mill sample number
- Lot number of the sample
- Name of Certified Source (Manufacturing Plant or Distribution Terminal)
- Available Mill Test result found at the quality control laboratory, including 3-day, ASTM C 109 test result.

Mn/DOT will report the result of the companion sampling to the Supplier of the Certified Source. If nonconformance is found, Mn/DOT will attempt to resolve the discrepancy as quickly as possible. Continued approval of the Laboratory will depend on the comparison of its test results with those of Mn/DOT's Laboratory. If major differences are found, a third party may arbitrate the difference.

F. Project Verification/Spot Check Sampling

Mn/DOT will take verification/spot check samples periodically at the ready-mix or batch plant and at precast production plants just before incorporation into the work. Test results, which do not comply with the Specifications, are subject to Mn/DOT Specification 1503 and continued out of tolerance results are considered sufficient cause to rescind cement or slag approval and for removal from the list of certified sources.

G. Basis of Removal from the List of Certified Sources

The Mn/DOT Concrete Engineer may remove a Manufacturer from the list of certified cementitious material sources based on the following:

1. If the Manufacturer does not supply Minnesota's state or county projects during a three consecutive year period.
2. If the project verification samples or companion samples fail and a review of the certified source's records indicate that there is cause for concern as to the quality of the cementitious material.
3. Failure to comply with the certification program approved by Mn/DOT.

H. Re-Certification of Certified Sources

The Mn/DOT Concrete Engineer will re-certify the cementitious material source upon satisfactory compliance with the area of concern as outlined in section G. This may require a re-submittal of all or a portion of sections C and D.

I. Documentation, Record Keeping and Tracking

Incorporation into Mn/DOT projects prior to Mn/DOT receiving certified Mill Test Data and any cementitious material that fails the above mentioned testing, is subject to Mn/DOT Specification 1503.

The certified source shall furnish with each shipment from the manufacturing plant (or the point of certification) to the distribution terminal and finally to the ready-mix plant, batch plant or pre-cast production plant, an invoice or bill-of-lading, and all available mill test data for the cement shipped. Each copy shall indicate the manufacturer of the cementitious material, manufacturing plant location; type of cementitious material, quantity, and approximate date the product arrived from manufacturing to the distribution terminal, and the state project number, if available.

It shall also bear the following certification statement with a signature of a responsible company representative (i.e. Manager of the Supplying Company or Quality Control Supervisor).

Cement Certification Statement

Insert Company Name certifies that the cement produced at insert plant and location conforms to ASTM and Mn/DOT Specifications for Type insert Type portland cement.

GGBFS Certification Statement

Insert Company Name certifies that the slag produced at insert plant and location conforms to ASTM and Mn/DOT Specifications for Grade insert Grade GGBFS.

For truck shipments, a copy of the bill-of-lading or invoice shall accompany each load, and the Project Engineer shall retain them at the project or ready-mix plant. For rail shipments, the Supplier shall mail these copies to the Project Engineer or the ready-mix plant.

When more than one project is supplied by a ready-mix plant, the plant shall furnish the Project Engineer, for each project, either a copy of each bill-of-lading or invoice, or a listing of the bills-of-lading or invoices representing the cementitious material incorporated into the project. This listing shall bear the signature of the plant representative.

Copies of all invoices, bill-of-lading and Mill Test Reports shall remain on file at the manufacturing plant, distribution terminal or ready-mix plant, batch plant or pre-cast production plant for a period of 3 years. Mn/DOT may require copies of these reports at any time. Storage of the certified mill test and ASTM C 917 data on a CD is encouraged.

J. Certification by Other States for Cement and Cement Blends

Mn/DOT will accept cement and cement blends certified in other States providing the process complies with the following agreement:

1. The host Agency requires that the portland cement plant within its boundaries have a laboratory compliant with ASTM C 1222 Standard Practice for Evaluation of Laboratories Testing Hydraulic Cement. This lab will perform testing on the applicable types of cement (ASTM C 150/AASHTO M 85*, ASTM C 595/AASHTO M 240, C 1157) produced and shipped for State Agencies consumption. AASHTO accreditation for hydraulic cement testing of the applicable cement types is acceptable. Agency laboratories used for verification testing must meet the same criteria. *NOTE: As modified by Spec. 3101.
2. The host State Agency requires that the portland cement plant within its boundaries have a printed, Agency acceptable quality control/quality assurance plan for the production of cements used by State Agencies. The plan must include commitments to comply with ASTM C 1222 and ASTM C 183 Standard Practice for Sampling and the Amount of Testing of Hydraulic Cement. The host State Agency verifies compliance with the quality control plan.

3. The host State Agency requires that the cement producer maintain and provide, for all lots of cement shipped, a compilation of mill reports in an electronic form. The host Agency will provide applicable data at least semiannually.
4. The host State Agency requires that the cement producer submit two samples of a regular portland cement (ASTM C 150/AASHTO M 85) and a blended portland cement (ASTM C 595/AASHTO M 240) or a performance specification cement (ASTM C 1157) if produced, semiannually for verification testing. The second sample is retained for independent analysis as needed.
5. The host State Agency requires that the cement producer submit reports for ASTM C 917 Standard Test Method for Evaluation of Cement Strength Uniformity from a Single Source for both regular portland cement and blended portland cement, if produced, at least semiannually. In lieu of ASTM C 917 sampling and testing, a report of production data analysis for the non-predominant cement manufactured at a cement plant is satisfactory.
6. The host State Agency requires that the cement producer maintains production and quality control/quality assurance records for at least seven years and make those records available if requested.
7. The host State Agency reviews submittals from the cement producer along with Agency test results. If deficiencies are discovered, the State Agency monitors corrective actions taken by the producer until the deficiencies are corrected. The reciprocal agreement State Agency is notified of the deficiencies and of each occurrence.
8. Any test results or submittals collected by the host State Agency are made available to the reciprocal agreement State Agency upon request.
9. All portland cement plant information and data is confidential within the limits of a public Agency and is for State Agencies information and inspection only.
10. Quality assurance test results of field samples, performed by a reciprocal State, are reported to the host Agency when non-compliance occurs. The reciprocal State Agency deals directly with the cement producer. The host State Agency takes action as described in Item 7. The host Agency notifies all reciprocal agreement State agencies when non-compliance occurs.
11. Portland cement tests or requirements beyond the standards stated above are provided to reciprocal State agencies by agreement between the host State and reciprocal State agencies.

5-694.115 FLY ASH

Fly ash is a pozzolan that meets the requirements of ASTM C 618 as modified by Specification 3115. Pozzolans are siliceous or siliceous and aluminous materials. Class F fly ash has little or no cementitious value. However, when in finely divided form and in the presence of moisture, it chemically reacts with the calcium hydroxide produced from the reaction of the portland cement and water to form compounds possessing cementitious properties. Class C fly ash has cementitious characteristics.

Two forms of fly ash are permitted for Agency work. Fly ash interground with cement and fly ash added separately to the mix. When the fly ash is interground with cement (Type IP cement), up to 20% by mass (weight) is permitted. Specification 2461 permits fly ash

replacement as a cement substitute up to 15% by mass (weight) for Class C and Class F fly ash. Special provisions may allow higher percentages of fly ash substitutions.

In addition to being economical, fly ash tends to reduce map cracking and abnormal expansion. This is probably due to its lower heat of hydration.

Fly ash in concrete also:

- C Reduces water requirements
- C Reduces bleeding
- C Retards time of set
- C Increases the modulus of elasticity
- C Reduces volume change
- C Reduces permeability
- C May increase resistance to sulfate reaction
- C Improves the workability of the mix due to the spherical shape of the fly ash particles

It also results in a higher ultimate tensile strength and a higher ultimate compressive strength; however, its 28-day strength is lower.

When fly ash or blended cements are substituted, the batch masses (weights) of the coarse aggregates are adjusted to compensate for the volume change due to the substitution. The use of fly ash or blends usually requires more air-entraining agent than plain concrete.

Fly ash added separately to the mix requires additional handling facilities; i.e., silos, etc., similar to those required for regular cement.

5-694.116 FLY ASH CERTIFICATION

A list of certified fly ash sources is available on the Mn/DOT Concrete Engineering Unit website at www.mrr.dot.state.mn.us/pavement/concrete/products.asp.

A. General

Mn/DOT will only accept fly ash from certified sources.

Fly ash shall meet the requirements of Specification 3115 for the class specified. Certification of any source of fly ash is based on the Supplier testing samples at the plant, with comparison sampling by Mn/DOT.

Acceptances of fly ash is judged on the basis of certified sources and upon satisfactory test results from verification/spot check samples from the fly ash at the time of incorporation into the concrete.

Approval is based upon fly ash production while a power plant is utilizing specific materials, equipment, and processes. Approval requires identification of the specific sources of the coal from which the ash is derived. Any changes in materials, equipment and processes will void any source approval and requires a new approval.

Fly ash produced immediately prior to shutdown and after start up is possibly quite different from the fly ash obtained during normal operation of the plant. This fly ash may not meet specifications. Companion samples tested by Mn/DOT that do not meet Specifications may result in voiding the source approval.

The system for managing the documentation of the inspection of fly ash was developed with four main objectives.

1. Mn/DOT projects must receive only certified fly ash.
2. The Fly Ash Supplier shall have a quality control program that is approved by Mn/DOT to verify the quality of the fly ash. This quality control program shall include a schedule of testing and procedures to discontinue the use of fly ash that does not meet Mn/DOT Specifications.
3. Record keeping must provide supporting evidence to certify the product at the power plant, and then track the fly ash from the point of certification to the ultimate destination. To make this system work, the Supplier must maintain records of fly ash quality tests, quantity and type of product certified, date of manufacture, date of shipment, and destination of fly ash. The Supplier shall provide up-to-date records and submit copies to Mn/DOT project staff prior to use.
4. The Producer's Certified Technician and Agency Plant Monitor shall check and sample fly ash arriving at ready-mix or batch plants for verification to ensure that unsuitable fly ash is not incorporated into projects.

B. Fly Ash Power Plant Certification Procedures

The Supplier at the power plant where the fly ash is manufactured (certified source) shall submit to the Mn/DOT Concrete Engineer a copy of the proposed Quality Control program. The Supplier shall submit a request for prior approval of this certification program in writing to:

Mn/DOT Concrete Engineer
Mn/DOT Office of Materials
1400 Gervais Avenue
Maplewood, MN 55109

The Quality Control Program shall outline, as a minimum, the following:

- Sampling Procedures
- Testing Procedures
- Quantity of fly ash for each lot
- Testing Frequency per lot
- Normal Testing or Reduced Testing Rates
- Noncompliance Procedures for Failing Materials
- Type of equipment used to manufacture the fly ash
- Raw Coal Source Location
- Layout of Power Plant and Process
- Production schedule of the power plant

- The Target Specific Gravity representing the fly ash at the Power Plant (this value is used for Verification testing)
- A Mn/DOT - Certified Source Companion Testing rate

Address any discrepancies from AASHTO, ASTM, or other standard methods or procedures. The program shall also outline what steps to take when samples tested fall outside the Specifications.

The Supplier shall specify the quantity of fly ash that they consider a “lot” sample. One bin or one day’s production are suggested quantities.

The following minimum testing rates and procedures shall apply:

1. Test one sample representing not more than 4 hours production at the power plant for the loss of ignition (LOI).
2. Test two samples representing not more than 48 hours production at the power plant for the specific gravity and percent retained on the 45µm (No. 325) mesh sieve.

The Mn/DOT Concrete Engineer may require an inspection of the plant to verify the equipment and the manufacturing process prior to certification or at any time during the manufacturing of fly ash.

All Suppliers at the power plants that manufacture fly ash shall have test records available for study by Mn/DOT personnel for at least three years following production of a fly ash lot.

C. Companion Sampling and Testing Program

The certified source and Mn/DOT shall agree on a rate and procedure for sampling and shipping a companion sample to the Mn/DOT Office of Materials Laboratory for companion testing. The minimum sampling rate is once per week for every week of production. The Supplier’s personnel shall take the sample for companion testing during manufacture in accordance with AASHTO T 127 or ASTM C 183 and retain those samples for a maximum of 6 months. The Supplier shall randomly select one weekly sample per month, split the sample and test one portion (“mill test”) by an approved laboratory as outlined in section E. Submit the other portion of the split sample (companion sample) within 10 days of date sampled to:

Mn/DOT Office of Materials
Attn: Fly Ash Comparison Sample
1400 Gervais Avenue
Maplewood, MN 55109

Include the following information with the companion sample:

- Date sampled
- Comparison sample number and mill sample number
- Lot number of the sample
- Power plant
- Supplier

- Class of fly ash
- Mill sample test result found at the quality control laboratory.

Mn/DOT will report the results of the Companion Sampling to the Supplier. If nonconformance is found, Mn/DOT will attempt to resolve the discrepancy as quickly as possible. Continued approval of the Laboratory will depend on the comparison of its test results with those of Mn/DOT's Laboratory. If major differences are found, a third party may arbitrate the difference.

D. Fly Ash Specifications and Testing

Fly ash specifications and testing shall comply with Mn/DOT Standard Specification 3115, AASHTO, ASTM, and the following:

<u>AASHTO</u>	<u>ASTM</u>	<u>TEST</u>
T 106	C 109	Test Method for Compressive Strength of Hydraulic Cement Mortar
T 105	C 114	Methods for Chemical Analysis of Hydraulic Cement
T 98	C 115	Test Method for fineness of Portland Cement by Turbidimeter
T 107	C 151	Test Method for Autoclave Expansion of Portland Cement
-	C 157	Test Method for Length Change of Hardened Cement Mortar and Concrete
T 137	C 185	Test Methods for Air Content of Hydraulic Cement
-	C 186	Test Method for Heat of Hydration of Portland Cement
T 131	C 191	Test Methods for Time of Setting of Hydraulic Cement by Vicat Needle
T 153	C 204	Test Method for Fineness of Portland Cement by Air Permeability Apparatus
-	C 265	Test Method for Calcium Sulfate in Hydrated Portland Cement
T 154	C 266	Test Method for Time of Setting of Hydraulic Cement by Gillmore Needles
T 186	C 451	Test Method for Early Stiffening of Portland Cement (Paste Method)
-	C 452	Test Method for Potential Expansion of Portland Cement Mortars Exposed to Sulfate
-	C 465	Specifications for Processing Additions for Use in Manufacture of Hydraulic Cement
-	C 563	Test Method for Optimum SO ₃ in Portland Cement

Acceptance is judged on the basis of time of set, false set, fineness, soundness, air content of the mortar, chemical analysis, and compressive strength. Mn/DOT may require additional testing if these tests do not continuously meet the requirements. They may also require additional testing of the product prior to shipment due to special considerations on that project. When required, special testing provisions are stated in the Contract documentation for the project.

Fly ash incorporated into Mn/DOT projects which fail the above-mentioned tests, is subject to Mn/DOT Specification 1503.

E. Approved Laboratory

A laboratory is considered approved if:

1. It is properly equipped and staffed to perform the tests required for an accepted quality control program and is accredited by a national laboratory certification program approved by Mn/DOT, or
2. Comparison samples with the Cement and Concrete Reference Laboratory (CCRL) are within acceptable tolerances.

Continued approval of the Laboratory depends on the comparison of its test results with those of Mn/DOT's Office of Materials Laboratory. If major differences are found, it is imperative that they are resolved as quickly as possible. Continued unresolved differences in test results are considered a basis for discontinuing laboratory approval.

F. Co-mingling of Fly Ash

Mixing of fly ash from different sources or of different classes in one storage bin or silo is not acceptable. At ready-mix plants and paving batch plants, empty the fly ash storage bin, as far as practical, prior to refilling from a different source.

G. Project Verification/Spot Check Sampling

Mn/DOT will take verification/spot check samples periodically at the ready-mix plant or at the batch plant. Test results that do not comply with the Specifications are subject to Mn/DOT Specification 1503, and continued out of tolerance results is considered sufficient cause to rescind approval to furnish fly ash and removal from the list of certified sources. See Figure A 5-694.116 for sampling of material from a truck.



Figure A 5-694.116

H. Basis of Removal from the List of Certified Sources of Fly Ash.

The Mn/DOT Concrete Engineer may remove a Supplier of fly ash from the list of certified fly ash sources based on the following:

1. If the project verification samples or companion samples fail and a review of the Supplier's records indicate that there is a cause for concern as to the quality of the fly ash.
2. If a Supplier does not supply Minnesota's state or county projects during a three consecutive year period.
3. If the power plant changes sources of coal or equipment for use in the manufacturing fly ash or the power plant changes its operation that may cause the consistency of the fly ash to change without notifying Mn/DOT.

I. Re-Certification of Certified Sources of Fly Ash

The Mn/DOT Concrete Engineer will re-certify the fly ash source upon written documentation from the Supplier that the area of concern as outlined in section H is corrected. This may require a re-submittal of all or a portion of section B requirements.

J. Documentation, Record Keeping and Tracking

The Producer/Supplier of certified fly ash shall furnish with each shipment an invoice or bill-of-lading for the project records. Each copy shall indicate the class of fly ash, quantity, date of shipment, a project number if available, and a means of tracking the fly ash shipment to the corresponding test data. It shall also bear the following certification statement with a signature of a responsible company representative (i.e. Manager of the Supplying Company or Quality Control Supervisor).

Fly Ash Certification Statement

Insert Company Name certifies that the fly ash produced at insert plant and location conforms to ASTM and Mn/DOT Specifications for Class insert Class fly ash.

For truck shipments, these copies of the bills-of-lading or invoice shall accompany each load, and the Project Engineer shall retain them at the project or ready-mix plant. For rail shipments, the Supplier shall mail these copies to the Project Engineer or ready-mix plant.

When more than one project is supplied by a ready-mix plant, the plant shall furnish the Project Engineer, for each project, either a copy of each bill-of-lading or invoice, or a listing of the bills-of-lading or invoices representing the fly ash incorporated in the project. This listing shall bear the signature of the plant representative.

Copies of all invoices, bills-of-lading and Mill Test Reports shall remain on file at the manufacturing plant, distribution terminal or ready-mix plant, batch plant or pre-cast production plant for a period of 3 years. Mn/DOT may require copies of these reports at any time. Storage of the certified Mill Test Data on a CD is encouraged.

5-694.120 AGGREGATES

Aggregates used in concrete are obtained from either natural gravel deposits or are manufactured by crushing quarried rock.

Natural deposits of sand and gravel may contain large amounts of deleterious aggregates such as shale and iron oxides. Therefore, some of these deposits do not meet concrete aggregate specifications. Beneficiating equipment can sometimes remove these undesirable materials during production. During processing, oversized material is either eliminated or reduced to usable size by crushing.

Crushed rock is generally obtained from quarried granite, quartzite, limestone, or trap rock. Trap rock is a general classification given to fine-grained, dark colored igneous rock. Crushed rock of the type classified as Class A, per Specification 3137.2B1, is not generally washed but is merely crushed and screened. Limestone can vary considerably in quality even in the same formation and careful selection by ledges is often necessary.

Fine aggregate (sand) produced by crushing quarried rock is not permitted.

5-694.121 AGGREGATE SIZE

Aggregates are divided into two general group sizes, fine and coarse. In many instances more than two actual sizes of material are used, due to a further subdivision by size of material within one or both of the groups. Figure A 5-694.121 shows an illustration of aggregate size from fine to coarse.

A. Fine Aggregate (Spec. 3126)

Fine aggregate is normally considered material that will pass through a sieve having 4.75 mm (No.4) mesh. Specifications require washed, natural sand, unless otherwise provided by the Special Provisions. In some instances, fine aggregate of two or three different sizes or from more than one deposit are used.

B. Coarse Aggregates (Spec. 3137)

Coarse aggregate is considered the material that is retained on a 4.75 mm (No.4) sieve. Two sizes of coarse aggregate are required whenever the maximum size of the aggregate is 25 mm (1 in.) or larger.



Figure A 5-694.121

5-694.122 CLASSES OF COARSE AGGREGATE

Coarse aggregate as used in concrete is classified into five groups per Specification 3137.2B.

- Class A is quarried granite, trap rock, or quartzite. The Engineer may also designate aggregate consisting of 100% crushed oversized gravel or boulders as Class A aggregate.
- Class B is all other quarried rock such as limestone and dolostone.
- Class C is natural or partially crushed gravel obtained from natural deposits.
- Class D is an approved mixture of two or more of the other classes.
- Class R is aggregate obtained from crushing and recycling concrete.

The Contractor must wash all coarse aggregate with the exception of Class A aggregate. The intermixing of aggregates of different classes is allowed only with approved blending belts or by batching operations.

5-694.123 AGGREGATE PROPERTIES

Determine aggregate properties prior to their use in concrete. The actual test procedures for fine and coarse aggregate may vary slightly but the purpose is the same.

NOTE: The accepted National Standard assumes calculations are based on a water temperature of 4°C (39°F) where 1 m³ of water has a mass of 1 kg (1 ft³ of water weighs 62.4 pounds). Mn/DOT calculates mix designs based on unit weight of water of 62.3 lb/ft³ that is more representative of the water at actual concrete temperatures.

A. Specific Gravity

Specific gravity is the ratio of the mass of a solid or liquid to the mass of an equal volume of distilled water at 4°C (39°F). In the specific gravity determinations for aggregates, the average water temperature is 21°C (70°F). Water at 21°C (70°F) weighs 998 kg/m³ (62.3 lb/ft³). However, for ease of calculation, the mass (weight) of water used for metric concrete mix designs is 1000 kg/m³.

For the fine aggregate, the specific gravity is computed by dividing the mass (weight) of oven-dry sand in grams by the volume of water displaced by the saturated surface dry sand in milliliters. For the coarse aggregate, the specific gravity is computed by dividing the mass (weight) of oven-dry material by the difference in mass (weight) of saturated surface dry aggregate in air and the mass (weight) of the same material immersed in water.

The specific gravity of aggregates that are predominantly limestone will vary from 2.58 to 2.65. The specific gravity of aggregates that have a high percentage of trap rock, granite, or quartzite will vary from 2.65 to 2.75.

B. Absorption

All aggregate particles contain small pores that vary in size and number from particle to particle. Oven-dry aggregate particles exposed to water absorb water into the pores. The rate

and extent of absorption into the particles depends on the size of the pores and the amount of water available for absorption.

For test purposes, the material is considered to have absorbed its maximum quantity of water when it has remained submerged in water at approximately 21°C (70°F) for 48 hours. The absorption factor of a test sample of material is determined by dividing the difference in mass (weight) between the saturated surface dry material and the oven-dry material by the oven-dry mass (weight).

C. Gradation and Fineness Modulus

The range in size and quantity of an aggregate is referred to as the gradation. To produce a uniform quality concrete, limitations are placed on the proportions of aggregate of the different sizes. The production of aggregate may require the removal of some material of one size or blending in material of another size so that the combined materials result in a gradation meeting requirements. The gradation is determined by sieving representative samples of the material through a series of different size sieves (largest size on top and in descending order) and recording the amount passing each sieve.

Sieves of selected sizes are designated as standard sieves used in determining a numerical gauge that indicate to some extent the relative gradation of a material. The gauge is referred to as "Fineness Modulus". The selected sieves are called the Fineness Modulus (F.M.) sieve series and consist of the following coarse aggregate sizes: 75 mm, 37.5 mm, 19 mm, 9.5 mm, 4.75 mm, 2.36 mm, 1.18 mm, 600 μm , 300 μm , and 150 μm (3 in., 1-1/2 in., 3/4 in., 3/8 in., No.4, 8, 16, 30, 50, and 100). The numerical value for F.M. is obtained by adding the percentage passing each of the sieves in the fineness modulus series, dividing this result by 100, and subtracting from 10. There are 10 sieves used for this analysis.

Generally, the F.M. is only calculated for the fine aggregate and the 75 mm, 37.5 mm, and 19 mm (3 in., 1-1/2 in., and 3/4 in.) sieves are not used for the gradation. Therefore, when calculating the F.M. for the fine aggregate the percent passing the remaining sieves is added up, divided by 100, and subtracted from 7. A greater F.M. represents a coarser sand. See 5-694.148 for a F.M. calculation.

Specification 3126.2G requires the F.M. determination on the fine aggregate. They permit a maximum variation of 0.2 from the established value for that source. The Mn/DOT Concrete Engineer will change the established value only when there are changes in plant operation or changes in the gradation of material in the deposit.

D. Absolute Volume

The absolute volume of a quantity of mixed particles is the summation of the solid volumes represented by each of the individual particles. All materials vary in their characteristics and have different specific gravities. It is necessary to know the average value of the specific gravity of the type of material in question to determine the absolute volume. The mass of 1 m³ of the solid material (absolute volume) is equal to the specific gravity of the material multiplied by 1000 (1000 kilogram equals the mass of 1 m³ of water). (The weight of 1 ft³ of the solid material (absolute volume) is equal to specific gravity of the material multiplied by 62.3 (62.3

pounds equals the weight of 1 ft³ of water at 70°F). The absolute volume (A.V.), expressed in m³ (ft³), of a given mass (weight) of material is equal to the dry mass (weight) of the material divided by the product of 1000 (62.3) and the specific gravity.

$$A.V. = \frac{Mass(kg)}{1000 \frac{kg}{m^3} \times Sp.G} = \frac{Weight(lb.)}{62.3 \frac{lb.}{ft^3} \times Sp.G}$$

E. Void Content

The void content of aggregate is that part of the bulk volume of the dry material that is occupied by air or void space.

In the void content test, 0.02832 m³ (1 ft³) of the dry aggregate is weighed and the absolute volume of solid material is determined. The void factor is equal to one minus the absolute volume of the aggregate in the unit volume. The void content will vary with the degree of consolidation.

To calculate the void content:

$$\text{Voids in } m^3 = \frac{1}{0.02832 m^3} \times \left\{ 1 - \left(\frac{\text{Unit Dry Mass (kg)}}{1000 \frac{kg}{m^3} \times Sp.G} \right) \right\}$$

$$\text{Voids in } ft^3 = 1 - \left(\frac{\text{Unit Dry Weight (lb.)}}{62.3 \frac{lb.}{ft^3} \times Sp.G} \right)$$

5-694.124 AGGREGATE HANDLING

See Figures A, B, and C 5-694.124.

Handle aggregates, from the time they are produced until they go into the mixer, in a manner to avoid:

- C Alteration of the gradation due to segregation
- C Contamination by deleterious foreign materials
- C Non-uniformity in moisture content

The Inspector must keep these points in mind during observations of routine operations, and correct without delay any operation that is conducive to the development of these conditions. Non-uniform materials cannot produce uniform quality concrete during batching operations regardless of the number of quality control tests. The best form of control is a uniform procedure in handling the aggregates to reduce the risk of the three conditions mentioned previously. Specification 2461.4A1 contains a number of detailed requirements which are designed as aids in securing more uniform materials. Review these requirements for compliance.

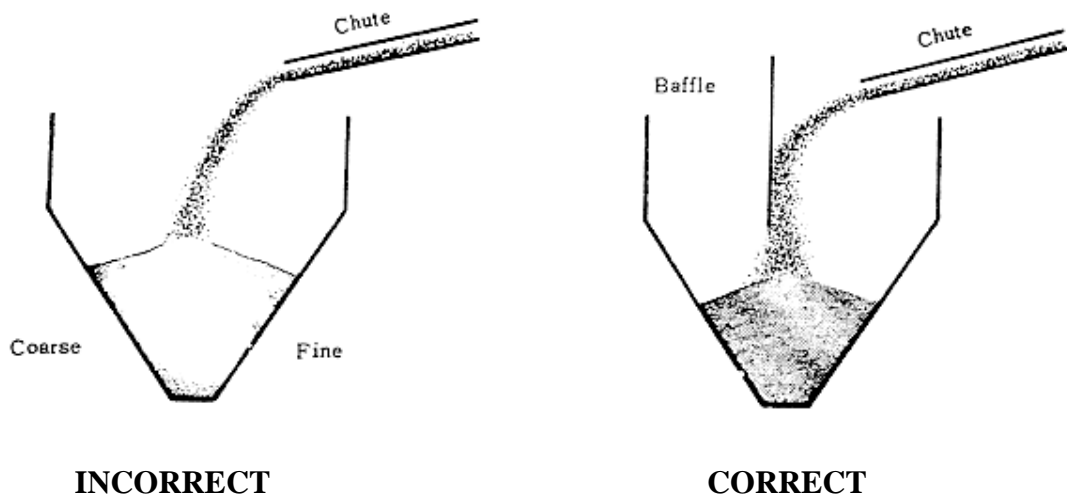

Figure A 5-694.124

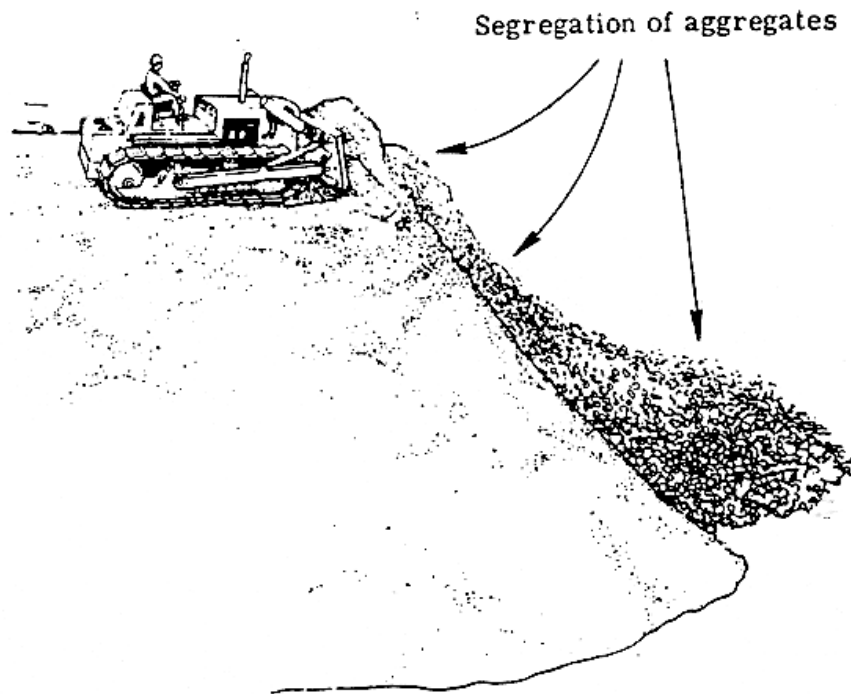

Figure B 5-694.124

STOCKPILING METHODS

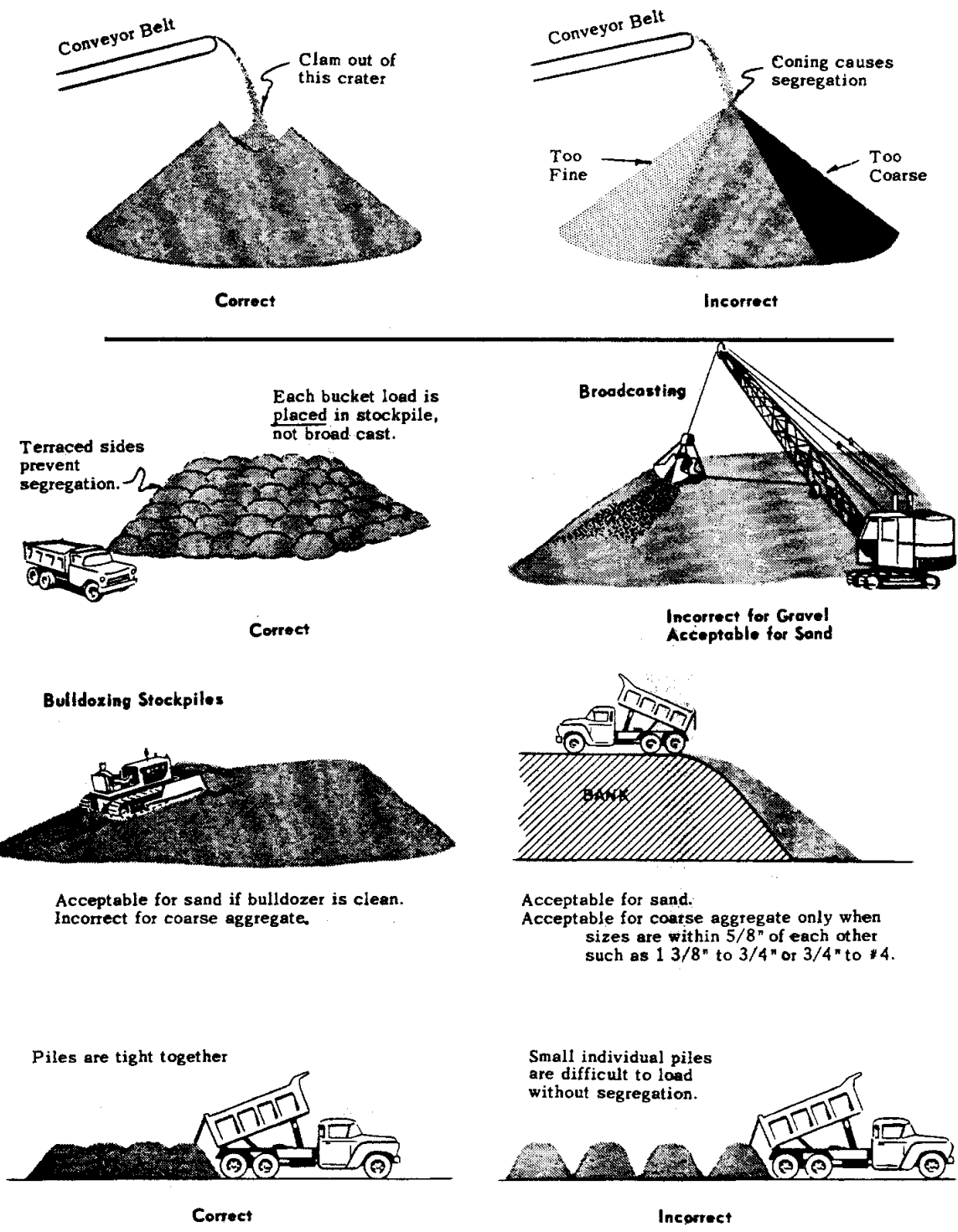

Figure C 5-694.124

5-694.125 AGGREGATE INSPECTION

Extensive inspection may occur at the producing plant during production. Such inspection, however, does not assure that the material is acceptable at the time of use. Make the final inspection and approval of the material when it is used.

Aggregates are generally hauled by either truck or rail from the producing plant to the job site. The cars commonly used are either hopper bottom cars that are normally unloaded with the use of belt conveyors under the tracks, or gondola cars that are unloaded with the use of a clam.

5-694.130 AGGREGATE SAMPLING

The Schedule of Materials Control defines the minimum number of tests required. When gradations or quality tests are running close to the tolerance limits, additional tests are required (process and acceptance verification (audit) tests) to assure that only materials meeting the Specifications are used.

At least one month prior to use of material from any new source or from new areas of old sources; the Agency shall coordinate with the Contractor in submitting samples to the Mn/DOT Office of Materials Laboratory for complete quality tests and design constants. Prior to submitting the required samples, the Agency shall obtain at least ten representative samples from stockpiles or the belt. Submit at least ten gradations of each coarse aggregate and fine aggregate fractions. Submit these gradings with the samples and include the 25 mm (1 in.) and 12.5 mm (1/2 in.) sieves in addition to the Specification sieves for the coarse aggregates.

The size of the coarse aggregate samples required is 135 kg (300 pounds) for each fraction. The proportions of each fraction is determined by the Producer/Contractor and approved by the Engineer. Seventy kilograms (150 pounds) of sand is usually sufficient for a complete analysis.

5-694.131 SAMPLING COARSE AGGREGATE AT A PRODUCING PLANT**A. Sampling from a Discharge Belt, Vibrating Screen, or Chute**

1. Make a rapid pass back and forth across the entire discharge area with a pail or other sampling device. The pail should have a perforated bottom to allow water to drain out.
2. **TAKE EXTREME CARE TO INTERCEPT THE FULL CROSS SECTION OF THE FLOW.** The mass (weight) of the individual particles determine the distance beyond the chute or belt that each particle travels; therefore, catch the sample as near to the discharge point as possible. This will assure that the sampled material is representative of the material produced for it includes fines nearest the conveyor that are easily missed.
3. If the material is not running uniformly, combine several samples obtained at equal time intervals and then reduce to the desired mass (weight) by quartering. An alternate procedure is running two or more tests and averaging the percentages.

B. Sampling from a Loading Hopper

1. When it is impractical to sample the material before it enters the loading hopper, it is possible to get a representative sample from the discharge gate of the hopper. The best method is to obtain the sample while the bin is empty. The steps usually followed are to:
 - a) Empty the bin into a truck.
 - b) Pound the bin sides to make sure no material is left in the corners of the bin.
 - c) Close the discharge gate just enough to direct but not restrict the flow of material.
2. The bin then serves as a chute, therefore, sample according to the chute method.
3. Any method of sampling from a bin other than that suggested above must have specific approval of the Engineer due to the difficulty in getting representative samples.

5-694.132 SAMPLING COARSE AGGREGATE AT A BATCHING PLANT

Whether the aggregate is previously inspected or not, it is necessary to test the material for final approval just prior to mixing. Obtain these samples by any of the following methods listed in order of preference. Take separate samples for gradation and moisture tests.

A. Sampling from a Conveyor Belt

When the aggregates are carried to the storage hoppers by a conveyor belt, obtain a sample by stopping the belt and completely removing all the material in a short section. See Figures A and B 5-694.132.

B. Sampling from a Goose-neck Conveyor

During filling of the storage bins from a conveyor belt, secure the samples from the end of the gooseneck conveyor. Use the method described previously under 5-694.131A.

C. Sampling from the Discharge Gates of the Storage or Batching Hopper

This method of sampling shows the gradation of material at time of use, however, segregation may occur within the bin.

Take samples by either leaning into the weigh bin with the container in hand or by suspending the container from a pipe or bar that rests on both sides of the weigh bin. Pass the container back and forth through the entire stream during charging of the weigh hopper. When using the latter sampling method, take care not to let the supporting devices deflect any of the material. See Figure C 5-694.132.

D. Sampling from a Stockpile

Coarse material has a marked tendency to segregate when allowed to fall freely from any height resulting in a pile of material much coarser at the outside of the pile. For this reason, it is very difficult to obtain a truly representative sample from large stockpiles of coarse aggregate. Stockpile sampling is the least reliable of methods and therefore is the least preferable method. If power equipment is available for use, secure several samples from a stockpile by taking portions from several areas of the pile. Combine the samples and quarter to provide a representative sample. See Figure C 5-694.134.

When power equipment is not available, take samples by hand shoveling. Take samples near the top of the pile, at or near the base of the pile, and at an intermediate point. To provide a representative sample, mix the individual samples, reduce to a single sample size by quartering and test the sample. When information on variations within the stockpile are desired in addition to the average condition, test the individual samples.

E. Sampling from Sumps

The sampling method used is the same as listed above for sampling a stockpile, except that sampling is from the sump.

F. Sampling from Railroad Cars

Take samples from railroad cars by digging three or more trenches across the car at points that appear representative of the material. Trench to at least 300 mm (1 ft.) below the surface of the aggregate and approximately 0.3 m (1 ft.) wide until the bottom of the trench is practically level. Take equal portions at nine equally spaced points along the bottom of the trench by pushing a shovel downward into the materials and not by scraping horizontally. The locations of two of the nine points are directly against the side of the car.

Combine the separate samples and reduce by quartering. If information on variation is desired, test the samples separately.

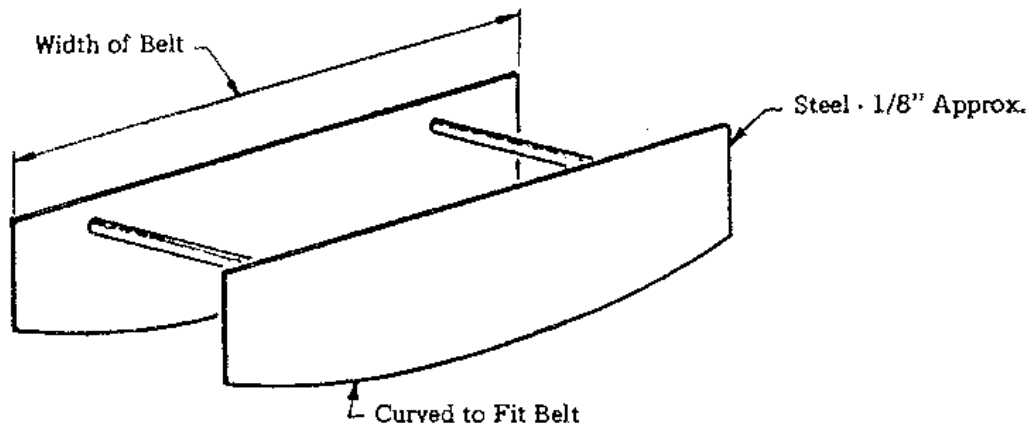

Figure A 5-694.132

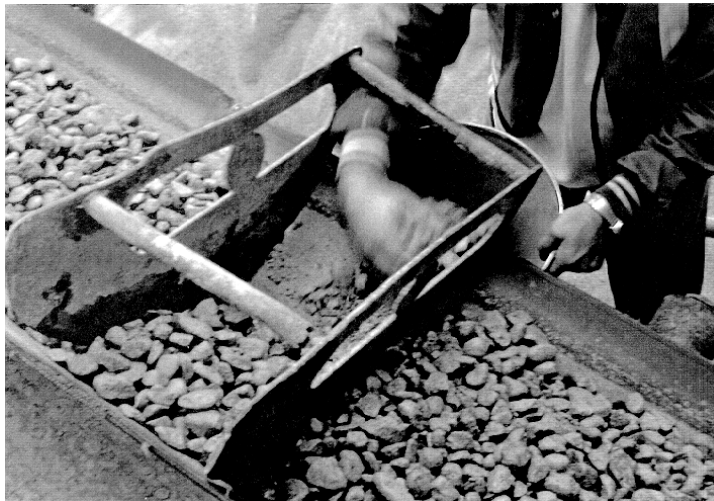

Figure B 5-694.132

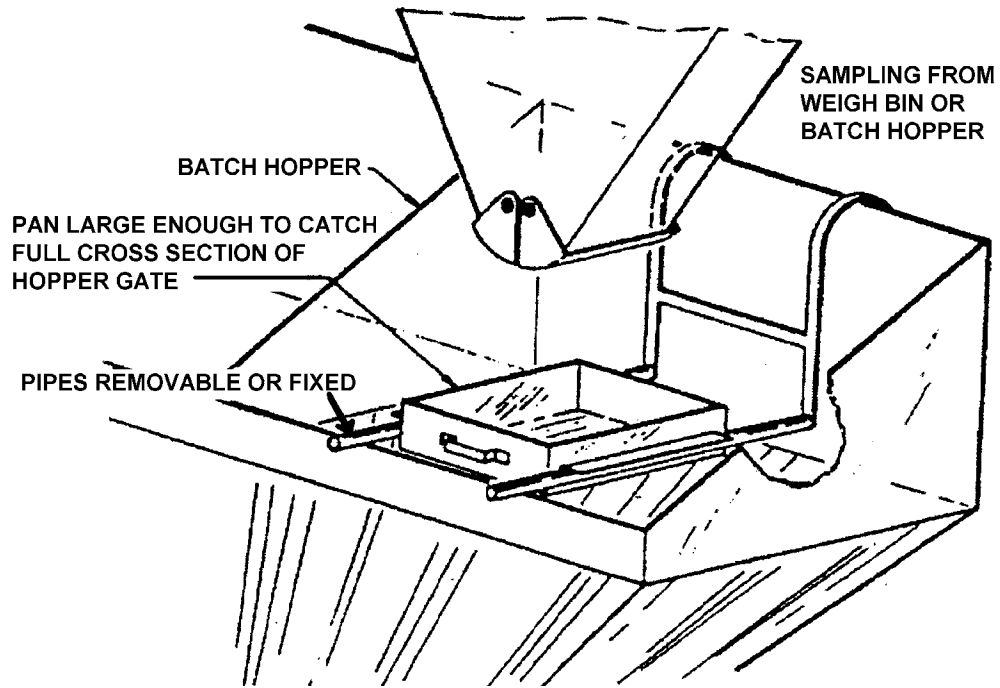

Figure C 5-694.132

5-694.133 SAMPLING FINE AGGREGATE (SAND)

Unlike coarse aggregate, damp sand does not segregate easily. However, the gradation varies considerably as it comes from the dehydrator during production. For this reason, do not sample sand during production from the dehydrator, the belt carrying material from the dehydrator, nor a bin that is supplied by either one. Take samples after re-handling of the sand to get a more representative sample. Sample sand with either a sampling tube or hand shoveling. Figures A and B 5-694.133 show a sampling tube and the procedure for sampling from trucks. Figure C 5-694.133 show sampling methods from coned and bulldozed sand stockpiles.

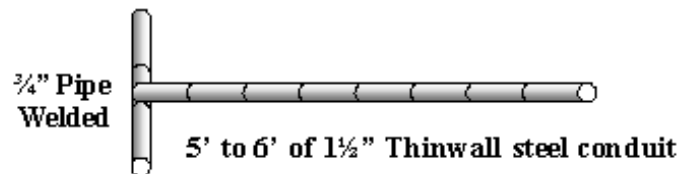
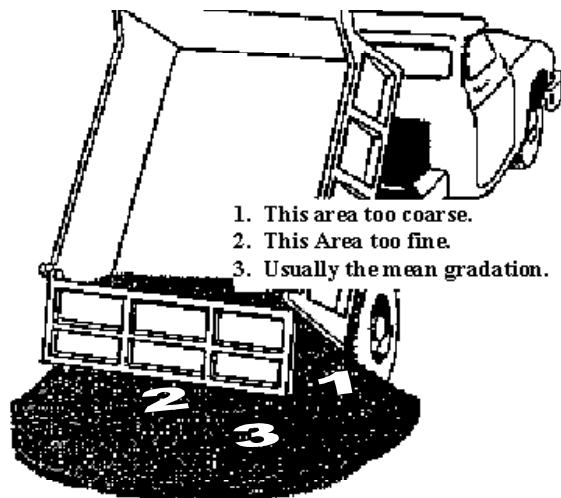
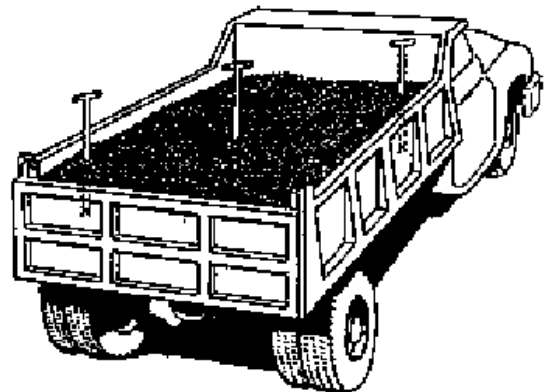

Figure A 5-694.133



Sampling Sand from Trucks



Sample with tube from diagonally opposite corners and from center.

* Hand shoveled samples should be dug from same areas.

Figure B 5-694.133

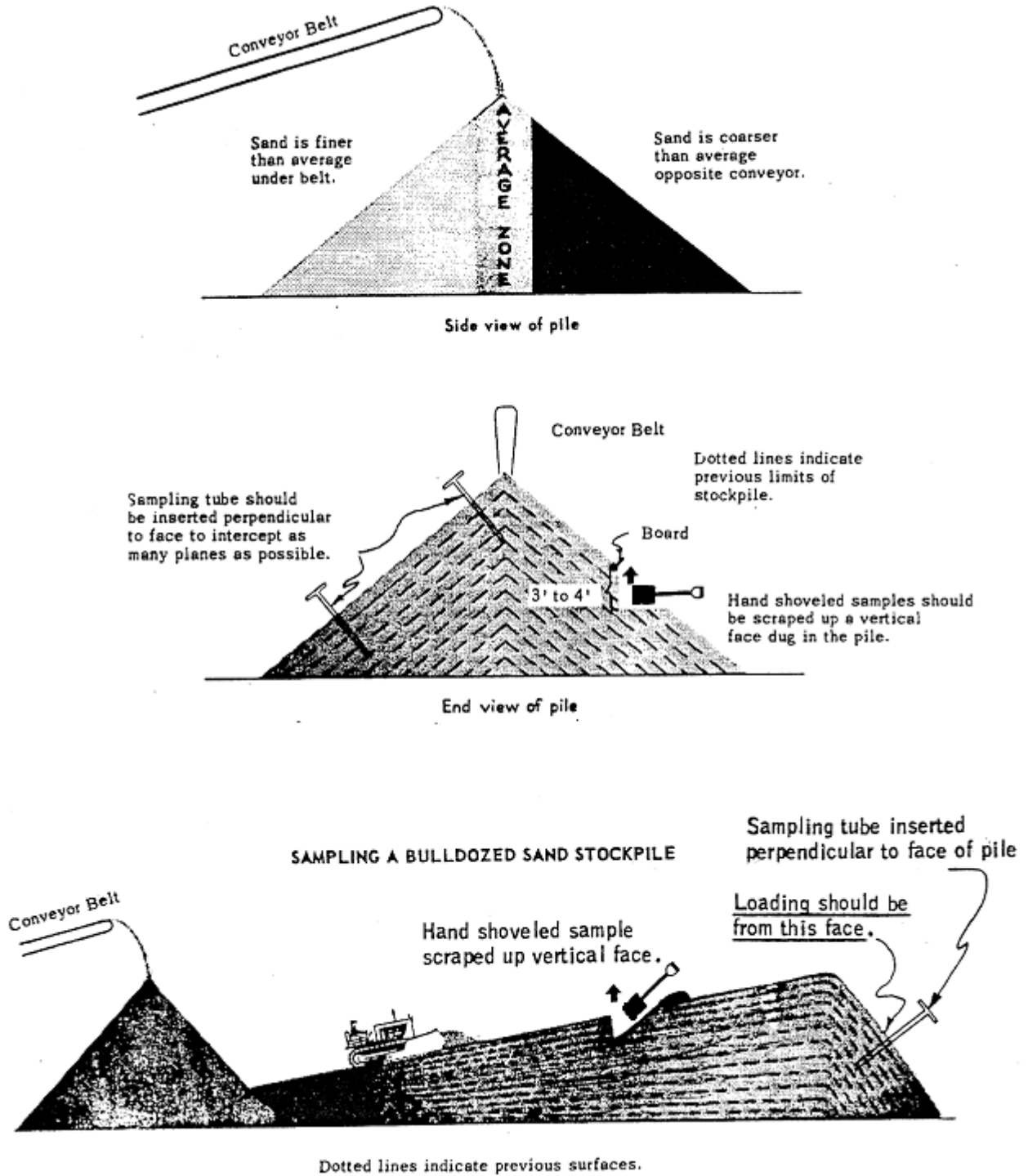

Figure C 5-694.133

When using a sampling tube, brush the dry sand aside and sample only the moist sand beneath. (Dry sand segregates easily.) Ram the tube into the pile perpendicular to the surface of the pile. Discard this sample. The tube is then lined with fine sand and the actual sample is not robbed of this fine sand. Ram the tube into the pile again to obtain the actual sample. Take samples from a number of locations and combine to get the proper sample size.

When using a hand shovel to secure samples, dig a 1 m (3 to 4 ft.) vertical face in the side of the pile and then scrape the shovel up the vertical face. A board shoved into the pile above the point of sampling will prevent the dry sand from running down and contaminating the sample. Take the samples from the sand stockpile near the top, near the base and at intermediate points. Either combine or run separately, depending on the information desired. Because samples near the base are normally “dirtier”, it is good practice to run a “Percent Passing the 75 μm (No.200) Sieve” test on a sample representing this area.

Whether the aggregate has been previously inspected or not, it is necessary to test the material for final approval just prior to mixing. Take these samples at any of the sampling points listed in 5-694.133.

5-694.134 SAMPLE SIZE

Blend the individual samples and reduce to the approximate sample size by use of a riffle splitter or by quartering. Keep in mind that the sample size is doubled for samples requiring companions.

<u>Aggregate Size</u>	<u>Mass</u>
CA-1, 2, 3	10 to 15 kg (25 lb.)
CA-5, 50	5 to 7 kg (10 to 15 lb.)
CA-60, 70, 80 and Sand	5 kg (10 lb.)

A. Riffle Splitter Method

See Figure A and B 5-694.134

1. Place the sample splitter on a flat surface.
2. Place two sample pans under the discharge chutes so that no material is lost.
3. Pour the sample into the splitter, moving back and forth over all the chutes to distribute the flow of material evenly. Continuously clear away material flowing into the pans to prevent clogging of discharge chutes. Repeat procedure at least four times to ensure the sample is thoroughly blended.
4. After the material has been blended it is then split in consecutive operations to the desired sample size. The last two pans should contain well-blended companions of the approximate sample size.

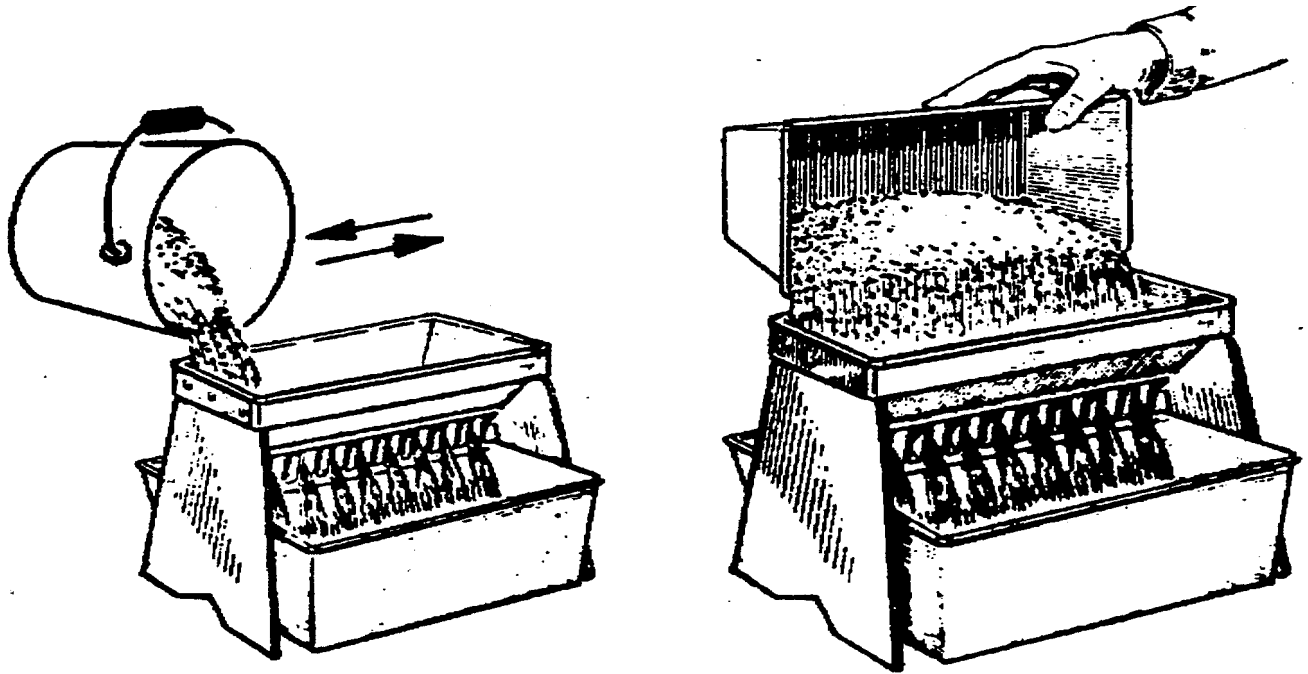

Figure A 5-694.134

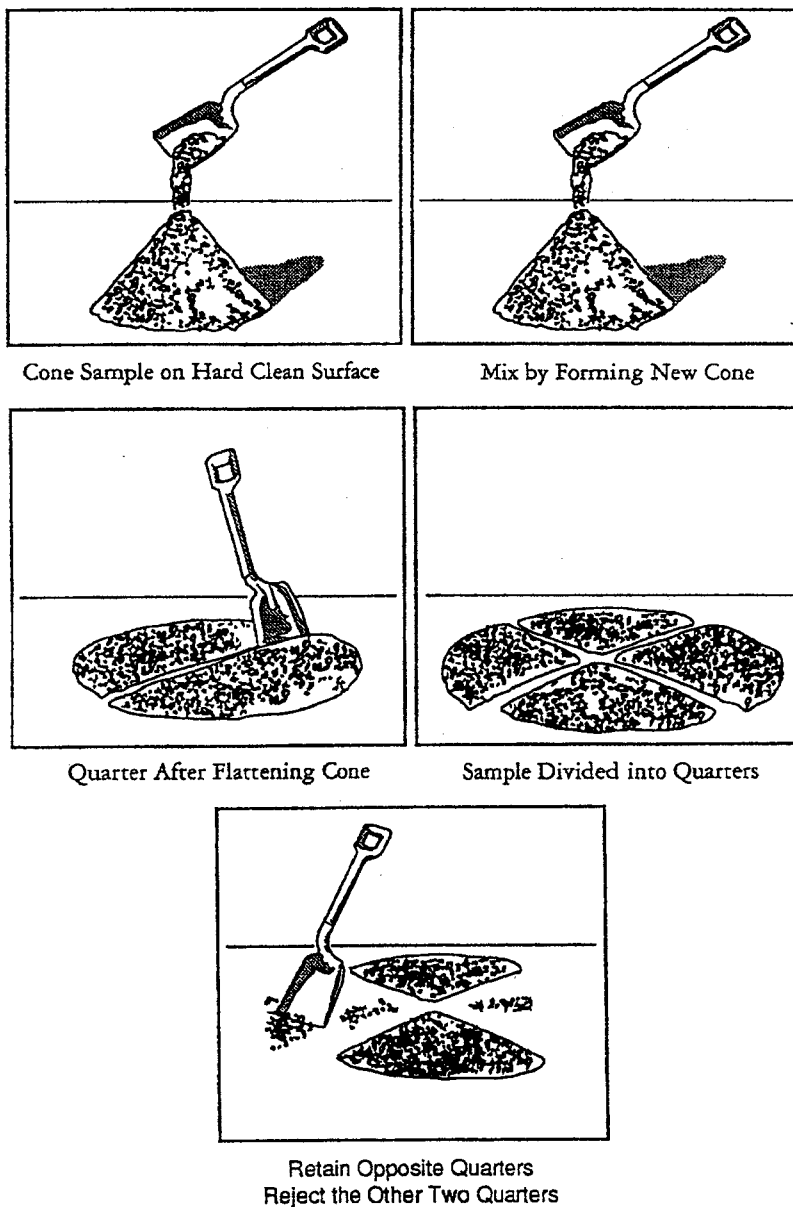

Figure B 5-694.134

B. Quartering Method

See Figure C 5-694.134

1. Place the aggregate on a clean flat smooth surface and mix well.
2. Form a low flat pile.
3. Cut the pile into four pie-shaped parts with a trowel.
4. Remove and discard two opposite quarters.
5. Remix the remainder of the aggregate. Take care to include the fines and dust
6. Continue to reduce the sample to a size that is satisfactory for testing by repeating the process. For samples requiring a companion, save both portions remaining in the last reduction process.

**Figure C 5-694.134**

5-694.135 SUBMITTING SAMPLES TO THE LABORATORY

Take samples on the day the material is used unless they are considered preliminary samples.

As shown in the Schedule of Materials Control, it is very important that these samples are accurately and completely identified. When more than one fraction of coarse aggregate is used, separation of bags for each size is required. Indicate on the *Sample ID Card* (Form 2410) that there is more than one fraction. Use a pencil to fill in the data on the cards since moisture in the sample may smear ink and make the writing illegible. See 5-694.751.

If a split sample is run in the field for paving either by the Contractor or by the Agency, record the results on the back of the sample card. This is done to check the accuracy of the field testing. Obtain all of these samples by splitting or quartering.

5-694.136 INDEPENDENT ASSURANCE SAMPLING AND TESTING

Independent Assurance sampling and testing is required on all Federal Aid, State Funds and County Federal Aid Projects. Assurance sampling is the direct responsibility of the District Materials Engineer. The District Materials Office will notify each project engineer on the *Project Summary of Independent Assurance Sampling and Testing* (Form IAT 24121) of the items and number of Independent Assurance samples required.

The purpose of this sampling is to verify the Inspector's sampling and testing procedures. The testing equipment used is also checked during Independent Assurance sampling. The project personnel are required to notify the District Materials Section when beginning any work requiring Independent Assurance sampling. It is necessary for scheduling to provide early notification. It is the responsibility of the project personnel to keep a record of Independent Assurance contacts to assure a sufficient number and timely contacts are made. Independent Assurance sampling is not a paper requirement; it is for the benefit of the Project Engineer that equipment and procedures meet requirements so that quality control testing is accurate.

5-694.140 AGGREGATE QUALITY

Before mixing operations begin, the Inspector should make it a standard practice to examine the concrete materials for general quality. The point of final inspection and approval of any material is at the time the material is placed in the work. For this final approval, the Project Engineer is responsible. Even though material was previously inspected and tentatively approved at the source, it may become altered or contaminated before it is used, or was shipped prior to inspection and testing without the knowledge of the Agency Inspector.

Physical properties of the material relative to aggregate class and gradation are readily checked, but factors affecting the general quality of the material are sometimes given slight attention or ignored entirely by the Agency. These factors include cleanliness and the presence of various kinds of deleterious materials. Inspect the aggregates for presence of soil lumps and clay balls. Before any material is actually used in concrete, the Project Engineer must assure that it meets all specification requirements relative to general quality.

5-694.141 AGGREGATE GRADATION TESTING

Both Plant Monitors and Certified Plant Technicians monitor the gradation of the aggregate as the work progresses.

A. Preliminary Tests

Because of the possible differences between the gradation furnished and the gradation used in the mix design, preliminary checks on gradation may indicate the necessity for a redesign of the mix before the work begins. If field test results are available, record them on the back of the *Sample ID Card* (Form 2410).

Samples of both fine and coarse aggregate confirm the conformance to the Specifications as well as insuring that the aggregate represents gradations that were used in past mix designs. Since there is practically no segregation of the fine aggregate in the normal handling of this material, secure average gradations by taking a few samples midway up the slope and around the outside of the pile. A much larger number of small individual samples are required for the coarse aggregate. Take these from the base to the top of the stockpile and about 0.3 m (1 ft.) below the exposed surface. Combine all of the small samples for any particular size of aggregate into one large sample and then quarter down to a sample of the desired size for testing. It is best to obtain preliminary samples by periodic sampling of the material at the producing plant.

B. Production Tests

Fine aggregate gradations usually do not vary much from the time of production. The coarse aggregate is subject to considerable change, due to abrasion and breakage of the particles and segregation of the materials in the handling operations. Check the percent passing the 75 μm (No.200) sieve if the aggregate looks dirty. Check the gradation of all sizes of coarse aggregate. Keeping the combined gradation at the desired value may require adjustment in the ratio between the sizes but consider that the proportion changes may affect the combined aggregate quality.

Running averages indicate the trends of aggregate gradation as incorporated in the work and are used as the basis for mix adjustments when necessary.

- Aggregate gradation testing is performed both in the field and in the laboratory. Process control (QC) testing is sampling and testing performed by the Producer/Contractor and acceptance (QA) testing is sampling and testing performed by the Agency.
- The Contractor and Agency Certified Technicians shall take samples of materials adequate in size to provide companion samples for both Contractor and Agency testing.
- Split the sample using a splitter.
- Test the QC companion sample when necessary and the QA verification samples in either the field or the laboratory. The Inspector must use a different sieve nest than the Contractor. If the test fails, recheck as soon as possible.
- The Contractor and the Agency shall report test results to one another to provide information for re-sampling and corrective action if required. Price reductions for

gradation failures are based on the Agency verification QA samples and not on Contractor QC tests in accordance with the Schedule of Price Reductions for Failing Materials unless an acceptance schedule is already included in the Contract.

5-694.142 AGGREGATE MOISTURE CONTENT

AGGREGATE MOISTURE TESTS FOR CERTIFIED READY-MIX PLANTS ARE PERFORMED BY THE PRODUCER'S CERTIFIED TECHNICIANS. AGGREGATE MOISTURE TESTS FOR LARGE CONCRETE PAVING PROJECTS ARE PERFORMED BY AGENCY CERTIFIED TECHNICIANS.

To ensure the incorporation of the design masses (weights) of oven-dry materials into the batch, it is necessary to determine how much moisture the aggregates carry. The results are used to make the proper allowances for this moisture in the weighing of the material. Figure A 5-694.142 shows different moisture states of aggregates. Mn/DOT bases all of the mix designs and testing on oven-dry aggregates.

The average concrete has total water content that occupies about 15% of the batch volume. Free water in the aggregates supplies about 25% of this total water. It is evident that the free water in the aggregates makes up from 3 to 4% of the batch volume.

The moisture content of the sand is determined more rapidly and accurately than for the coarse aggregate. Take care in securing these samples so they are representative of the moisture content and gradation of the materials. Variations in gradations of the coarse aggregate can result in excessive variation in the moisture content since a large number of small particles have a greater total surface area and therefore a higher moisture content than one large particle of the same mass (weight).

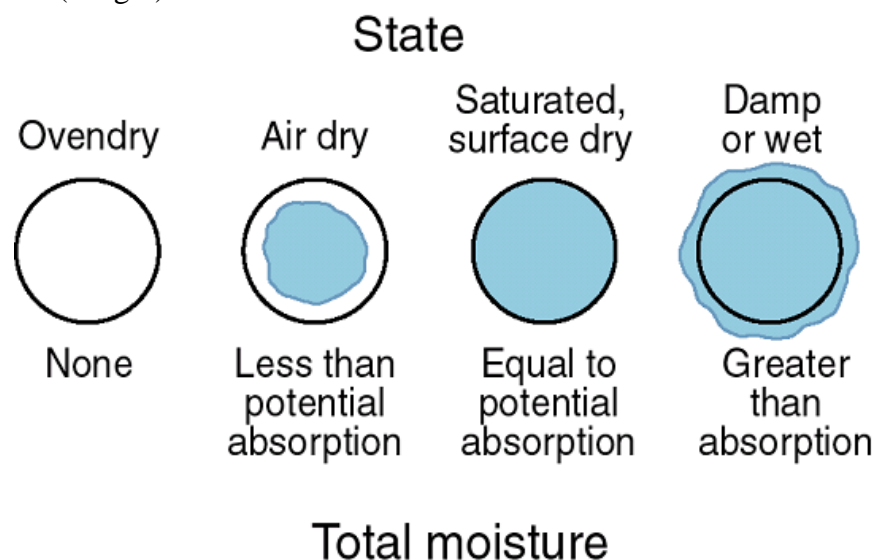

Figure A 5-694.142

A. Certified Ready-Mix

The Producer's Certified Technician must test the aggregates for moisture, and give the results to the batch person prior to the start of Agency production each day. The Technician may take moisture samples the night before the pour for aggregates representative of materials used the next day. The Agency Monitor should observe the Technician perform the test if possible. The Monitor should check the Technician's calculations and verify that the results are reasonable for the condition of the aggregates and the recent and current weather conditions.

B. Concrete Paving

On paving work where batching is continuous day after day and new material is likewise received every day, continuous moisture testing is essential. The Agency Monitor should study the sequence of the material handling operations, and try near the end of each day, to secure tests of the materials in the condition that will exist the following morning. In this way the scales are correct at the beginning of the day. Proper control consists not only in the number of moisture tests made in a day, but also in the ability to observe and analyze the whole sequence of the handling operations and the timing of the tests made with these handling operations. The Contractor and Agency should recognize the critical periods in the handling cycle and anticipate probable changes in moisture content and then time tests accordingly.

C. Oven Dry Moisture Test Procedure

Record all test results on the *Concrete Batching Report* (Form 2152). See Figure A 5-694.718.

1. Obtain a representative sample of each aggregate. To minimize moisture loss, limit handling of sample.
2. Weigh approximately 500 g of fine aggregate and 2000 g of coarse aggregate.
3. Determine wet masses (weights) of samples immediately after sampling to minimize the moisture loss by evaporation. See Figure B 5-694.142.
4. After the wet mass (weight) is determined, dry the aggregate until all moisture is removed. Take care in the drying process so that none of the aggregate particles are lost. Extreme heat may cause some of the materials to explode. If any of the particles are lost, the resultant dry mass (weight) will indicate higher moisture content than the material actually contained.
5. Dry the aggregates to a constant mass (weight) and determine the dry mass (weight). See Figure C 5-694.142. Constant weight is determined by alternately weighing and drying the material until there is no significant weight loss.
6. Total moisture is determined by dividing the weight lost in drying by the dry weight of the sample.

**Figure B 5-694.142****Figure C 5-694.142**

D. Moisture Probes and Calibration

In addition to the standard moisture test, the Producer may choose to determine moisture content in the fine aggregate by use of an Agency approved moisture probe. See Figure D 5-694.142. For Agency approval of a moisture probe, calibration is required before each construction season.

To calibrate a moisture probe, follow the procedures outlined below:

1. Note the reading on the moisture probe.
2. Obtain a fine aggregate sample as it passes the probe.
3. Note the reading on the moisture probe again. Confirm the two readings are within 0.5% of each other. Average the two readings.
4. Divide the sample into thirds, and determine the moisture content of each of the three portions by the oven-dry method described in 5-694.142C. Confirm the readings are within 0.5% of each other. Average the three results.
5. Compare the results of the moisture probe average (Step 3) and the oven-dry method average (Step 4).
 - a. If the results are within 0.5%, document the results in the plant diary for Agency approval.
 - b. If the results are not within 0.5%, wait at least one hour or a minimum of two loads and repeat Steps 1 - 5.
6. If neither of the tests is within 0.5%, recalibrate the probe according to the manufacturer's recommendation.

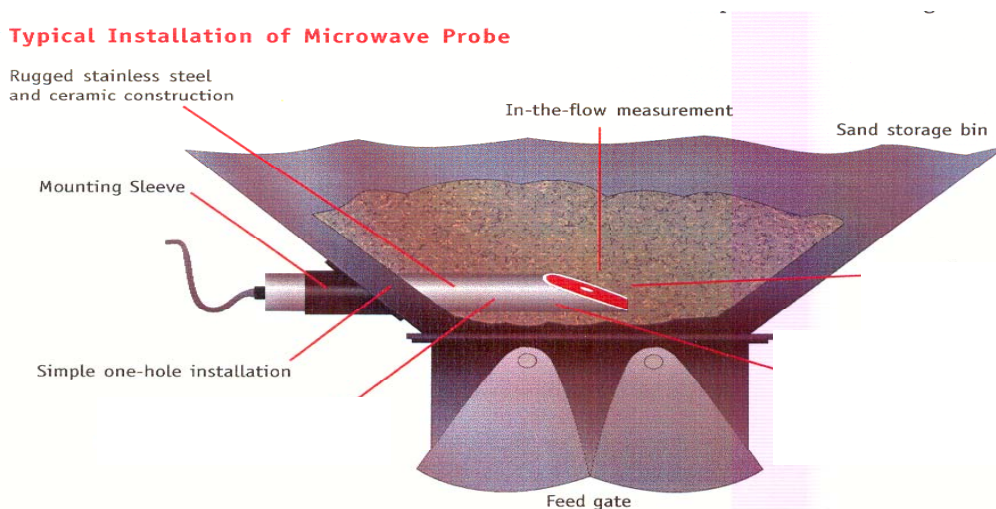

Figure D 5-694.142

5-694.143 COMPUTATION OF SCALE SETTING

The cementitious content in the batch shall conform to the quantity shown in the design.

The Producer shall adjust the dry aggregate batch masses (weights) shown in the design based on the amount of moisture they carry. See the *Concrete Batching Report* (Form 2152) in 5-694.718.

The water indicated in the design is the maximum total water. Design water content is an estimate based on previous experience with materials from the same source or on established rules of design. The total water in a concrete batch consists of the combined free water carried by all of the aggregates and the actual water added to the concrete batch at the mixer.

In normal operations, less mixer water than indicated by the moisture test is added to the first batch and the consistency is observed during the mixing period. If the batch appears too dry in the mixer, additional water is added until the specified consistency is obtained. The mixer water for the second batch is increased by the amount added during the adjustment process for the batch. Subsequent batches are controlled by the consistency obtained with the water content maintained as constant as possible. If the mixing water, allowing for changes in aggregate moisture content, consistently varies from tolerances, the Producer shall run another moisture test, check and repair the equipment, and/or request a revision of the mix design. Contact the Mn/DOT Concrete Engineering Unit at 651-779-5573 if the total actual water exceeds the design water by more than 4 percent.

Sometimes the aggregate is so dry that its total moisture factor is less than its absorption factor. In this case the free water factor is a negative number and the material will actually absorb water from the mix.

5-694.144 AGGREGATE GRADATION TESTING PROCEDURES

NOTE: FOR AGENCY AND CONTRACTOR TESTING, MECHANICAL SHAKERS ARE REQUIRED.

The Specifications provide that the aggregates meet certain requirements. Standard test methods are used to determine whether the materials meet these requirements.

Procedures in the Central and District Laboratories are in accordance with procedures found in the Mn/DOT Laboratory Manual. The field procedure is outlined below:

Check or calibrate the following equipment each year:

- Mechanical shaker
- 25 kg (60 lb.) capacity electronic balance, dairy scale, or beam balance with weights
- Necessary sieves and bottom
- Necessary pails and containers

If any of these pieces of equipment do not bear a date of calibration within the past year, exchange it for one that does.

5-694.145 COARSE AGGREGATE SIEVE ANALYSIS

Record all results on the *Concrete Aggregate Worksheet* (Form 21763) for ready-mix or the *Concrete Aggregate Worksheet – JMF* (Form 21764) for paving. See Figure A 5-694.720 and Figure A 5-694.737.

A. Equipment

- Mechanical shaker
- 25 kg (60 lb.) capacity electronic balance, dairy scale, or beam balance with weights
- Necessary sieves and bottom
- Necessary pails and containers

B. Samples

1. Secure a representative sample.
2. Reduce the sample to the required size.
3. Allow excess water to drain prior to the test.

C. Procedure

1. Set-up nest of required sieves in a mechanical shaker. The use of a 25.0 mm (1 in.) and a 12.5 mm (1/2 in.) filler sieve is recommended to lighten the load on the 19.0 mm (3/4 in.) and the 9.5 mm (3/8 in.) sieves, respectively. See Figure B 5-694.145 for the *Maximum Allowable Quantity of Material Retained on a Sieve*.
2. Place empty pail on scale and tare to zero. See Figure A 5-694.145.

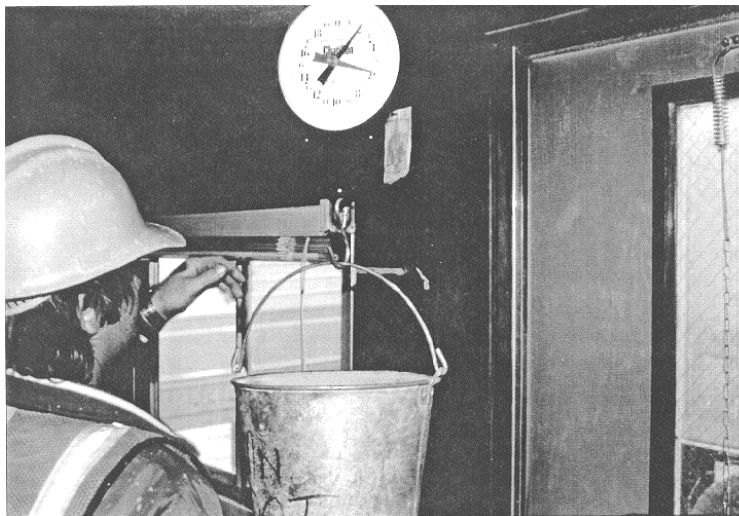

Figure A 5-694.145

3. Weigh the sample and record mass (weight) to nearest 1 g (0.1 lb.).
4. Pour the sample into the nest of sieves and shake for a minimum of 7 minutes. DO NOT hand fit rock through a sieve.

NOTE: CRUSHED ROCK SUCH AS LIMESTONE, GRANITE, ETC., WILL REQUIRE ADDITIONAL SIEVING TIME.

5. Examine material on each sieve for clay balls; if present, run a separate test for clay balls in coarse aggregate. See 5-694.147.
6. Weigh and record the amount retained on each individual sieve. Total the amount retained on each sieve and the bottom pan. This check total must weigh within $\pm 0.3\%$ of the original mass (weight). When weighing the sample with a dairy scale, the check total must be within ± 0.2 lbs.
7. Calculate and record the amount passing each sieve. The mass (weight) passing any sieve is the cumulative mass (weight) of all materials retained on each individual smaller sieve and the bottom.
8. Calculate and record the percent passing each sieve by dividing the amount passing each sieve by the check total mass (weight). Report percentages for each of the sieves to the nearest whole number. Refer to Figure A 5-694.720.

Example :

Amount passing 9.5 mm (3/8 in.) sieve = 1.5 lb.

Check Total = 13.4 lb.

$$\% \text{ Passing } 9.5 \text{ mm (3/8 in.) sieve} = \frac{1.5 \text{ lb.}}{13.4 \text{ lb.}} = 11\%$$

9. Calculate the composite gradation of the materials when more than one fraction is required. The proportion of each fraction of coarse aggregate will vary for different sources of aggregate, since the proportions are dependent upon the actual gradations of the individual fractions.

- a. Determine the proportions (percentages) of each fraction of the aggregates required to meet the specification.

Example :

70% of 19 mm - (3/4-) material

30% of 9.5 mm - (3/8-) material

100% of CA - 50

- b. The composite percent passing any particular sieve is found by multiplying the percentage of the material required (Step 9a.) by the percentage passing each sieve (Step 8) and adding these values together. Record percentages for each of the sieves to the nearest whole number.

Use the 9.5 mm (3/8 in.) sieve as an example. Refer to Figure A 5-694.720.

Example:

70% of 11 = 8

30% of 13.3 = 28

Total Composite of 9.5 mm (3/8 in.) sieve = 36%

Consult the Aggregate Producer or Contractor regarding the proposed proportions before the job starts. It is the Contractor's responsibility to determine aggregate proportions, not the Agency's.

For process control testing (QC), the percent passing each sieve size for each of the aggregate fractions for all samples tested are recorded on the *Weekly Concrete Aggregate Report* (Form 2449). See 5-694.721.

For acceptance testing, the verification (QA) sample test results are reported by the Agency on the *Weekly Certified Ready-Mix Plant Report* (Form 24143). See 5-694.725.

MAXIMUM ALLOWABLE QUANTITY OF MATERIAL RETAINED ON A SIEVE
References from ASSHTO T 27 - 97¹ and/or Mn/DOT Standards
{+ #4 Sieve Quantities interpolated by this formula = [(2.5) x (Sieve opening, mm) x (Sieving Area, M2)] }

Nominal Dimensions of Sieve	Sieving Area m ²	203mm	8"	305mm	12"	305mm x 305mm	12"x12"	360mm x 360mm	14"x14"	400mm x 400mm	16"x16"	368mm x 572mm	14.5 x 22.5
In.	Mm	kg	lbs	kg	lbs	kg	lbs	kg	lbs	kg	lbs	kg	lbs
4	100	-	-	-	-	23.23	-	-	-	-	-	-	-
3 1/2	88	-	-	15.08	33.2	20.90	-	-	-	-	-	-	-
3	75	-	-	12.56	27.7	17.42	-	-	-	-	-	39.47	87.0
2 1/2	63	-	-	10.55	23.3	14.63	-	-	-	-	-	31.15	69.4
2	50	1.56	7.8	8.38	18.5	11.61	25.5	15.79	34.8	20.59	45.4	26.31	58.0
1 1/2	37.5	2.67	5.9	6.28	13.8	8.71	19.2	11.84	26.1	15.47	34.1	19.73	43.5
1 1/4	31.5	2.24	5.6	5.28	12.6	7.32	16.1	9.96	21.9	13.01	28.6	16.58	36.5
1	25	1.78	3.9	4.19	9.2	5.81	12.8	7.89	17.4	10.30	22.7	13.15	29.0
3/4	19	1.35	3.0	3.18	7.0	4.41	9.7	5.99	13.2	7.85	17.3	10.00	22.0
5/8	16	1.14	2.5	2.68	5.9	3.72	8.2	5.06	11.2	6.61	14.6	8.42	18.6
1/2	12.5	0.89	2.0	2.09	4.6	2.90	6.4	3.95	8.7	5.17	11.4	6.57	14.5
3/8	9.5	0.67	1.5	1.59	3.5	2.21	4.9	2.99	6.6	3.90	8.6	5.00	11.0
3	6.3	0.45	1.0	1.06	2.3	1.46	3.2	1.99	4.4	2.60	5.7	3.32	7.3
4	4.75	0.33	0.7	0.80	1.8	1.10	2.4	1.50	3.3	1.95	4.3	2.50	5.5

{- #4 Sieve Quantities interpolated by this formula = [(7kg/m²) x (Sieving Area in m²)] Mn/DOT Lab Manual

8" round sieves with openings smaller than the #4 (4.75mm) sieve = [7000 g x 0.02850] = 199.5 g 200 grams
 12" round sieves with openings smaller than the #4 (4.75mm) sieve = [7000 g x 0.06700] = 469.0 g 450 grams

Figure B 5-694.145

5-694.146 COARSE AGGREGATE PERCENT PASSING 75 μm (No.200) SIEVE TEST

Record all results on the *Concrete Aggregate Worksheet* (Form 21763) or the *Concrete Aggregate Worksheet – JMF* (Form 21764) for paving. See Figure A 5-694.720 and Figure A 5-694.737.

A. Apparatus

- Electronic scale or beam balance with weights (sensitive to 0.1 g).
- Standard 200 mm (8 in.) diameter, 1.18 mm (No.16), and 75 μm (No.200) sieves with necessary brushes for cleaning sieves and pans.
- Pans or bowls of a sufficient size to contain the sample covered with water and to permit vigorous agitation without loss of any part of the sample or water, and a spatula for stirring the sample.
- Stove or oven of sufficient size capable of maintaining a uniform temperature for drying samples at $110^{\circ}\text{C} \pm 5^{\circ}\text{C}$ ($230^{\circ}\text{F} \pm 9^{\circ}\text{F}$).
- A detergent, dispersing agent, or other wetting solution.

NOTE: The use of a mechanical apparatus to perform the washing operation is not precluded provided the results are consistent with those obtained using manual operations. The use of some mechanical washing equipment with some samples may cause degradation of the sample.

B. Sampling

Secure a representative sample of the aggregate for testing. Reduce the sample obtained to a mass (weight) after drying of not less than:

<u>Aggregate Size</u>	<u>Minimum Mass</u>
CA-5 through CA-8	2500 g (6 lb.)
CA-1 through CA-4M	5000 g (10 lb.)

The test sample is the end result of the reduction. Reduction to an exact predetermined mass (weight) is not permitted.

B. Procedure

1. Place balance on a firm level base. Check for zero balance.
2. Dry the test sample to constant mass (weight) at a temperature of $110^{\circ}\text{C} \pm 5^{\circ}\text{C}$ ($230^{\circ}\text{F} \pm 9^{\circ}\text{F}$) and weigh to the nearest 0.1 g of the mass (weight).
3. Add sufficient water to cover the sample. If necessary, add a detergent, dispersing agent or other wetting solution to the water to assure a thorough separation of the material finer than the 75 μm (No.200) sieve from the coarser particles.
4. Agitate the sample with sufficient vigor to result in complete separation of all particles finer than the 75 μm (No.200) sieve from the coarser particles, and to bring the fine material into suspension.
5. Pour the wash water slowly over the nested sieves, arranged with the coarser sieve on top; save the material retained on the sieves. Take care to avoid, as much as possible, pouring the coarser particles onto the sieves. See Figure A 5-694.146.

6. Repeat the washing process until the wash water becomes clear.
7. Wash the material retained on the sieves back into the sample, pour off the excess water, then dry sample to constant mass (weight) at $110^{\circ}\text{C} \pm 5^{\circ}\text{C}$ ($230^{\circ}\text{F} \pm 9^{\circ}\text{F}$) and measure to the nearest 0.1 g of the sample mass (weight).

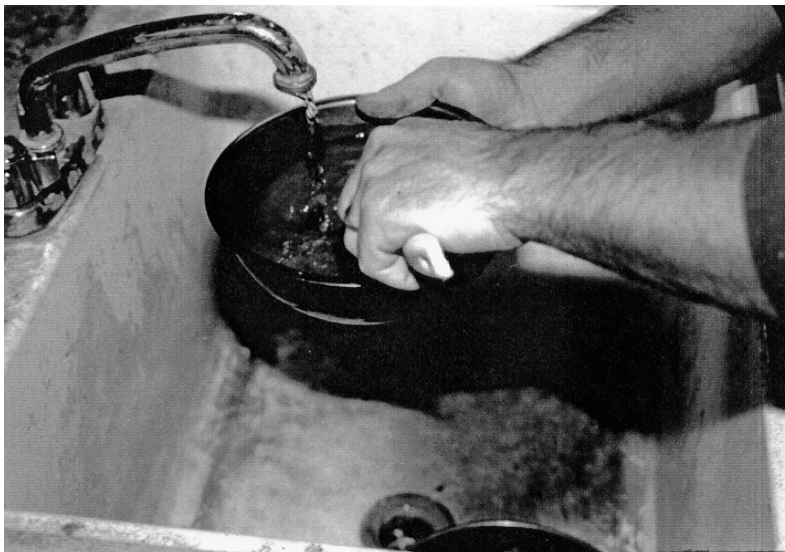

Figure A 5-694.146

The difference between the original sample mass (weight) and the washed sample mass (weight) is the loss in washing of the material passing the $75\ \mu\text{m}$ (No.200) sieve.

NOTE: The sample was dried, weighed, washed, re-dried, and re-weighed without leaving the original pan. This is done to prevent inadvertent loss of material.

D. Calculation

Calculate the percent of material passing a $75\ \mu\text{m}$ (No.200) sieve by washing as follows:

$$\text{Matl. Passing } 75\ \mu\text{m} (\#200) = \left(\begin{array}{l} \text{Original Dry Wt. of Sample} \\ - \text{Wt. of Dry Washed Sample} \end{array} \right)$$

$$\% \text{ Passing } 75\ \mu\text{m} (\#200) = \frac{\text{Matl. Passing } 75\ \mu\text{m} (\#200) \times 100}{\text{Original Wt. of Sample}}$$

Report to the nearest 0.1%.

5-694.147 COARSE AGGREGATE CLAY BALLS

If clay balls are present in the material, determine the quantity of clay balls by mass (weight) of the material by taking a sample of 10 to 15 kg (25 to 40 lb.) of representative aggregate. Remove all clay balls and clay ball conglomerates from the sample, dry to a constant mass (weight), and weigh to the nearest 0.1 g.

The percent of clay balls is calculated as follows:

$$\% \text{ of Clay Balls} = \frac{\text{Dry Qty. of Clay Balls} \times 100}{\text{Original Dry Qty. of Sample}}$$

Report to the nearest 0.1%.

5-694.148 FINE AGGREGATE SIEVE ANALYSIS

Record all results on the *Concrete Aggregate Worksheet* (Form 21763) for ready-mix or the *Concrete Aggregate Worksheet – JMF* (Form 21764) for paving. See Figure A 5-694.720 and Figure A 5-694.737.

A. Apparatus

- Standard 200 mm (8 in.) diameter fine sieves with cover and bottom: 9.5 mm, 4.75 mm, 2.36 mm, 1.18 mm, 600 μm , 300 μm , 150 μm , 75 μm (3/8 in., No.4, 8, 16, 30, 50, 100, 200) sieves
- Brushes for cleaning pans and sieves
- Mechanical shaker
- Necessary bowls, pans, or pails
- Stove for drying samples

B. Samples

- Secure a representative sample of the sand.
- Reduce the sample to the wet mass (weight) of approximately 500 g.

Use a filler sieve or reduce the sample size if more than 200 g is retained on any sieve.

C. Procedure

1. Place balance on a firm base. Check for zero balance.
2. Dry the sample to a constant mass (weight). Cool, weigh, and record mass (weight) to the nearest 0.1 g.
3. Wash the sample, in the same pan, over the 75 μm (No.200) sieve by adding water to the sample, stirring the sample with a spoon or spatula and pouring the cloudy water on to the 75 μm (No.200) sieve, being careful not to lose any of the material or allow the 75 μm (No.200) sieve to overflow. Repeat this procedure until the water is fairly clean.

4. Rinse the 75 μm (No.200) sieve back into the pan taking care not to lose any of the material. Lightly tap the outside of the pan and let stand until the fines have settled out of the water. Carefully pour off excess water, again taking care not to lose any material.
5. Dry the sample to a constant mass (weight), cool, weigh and record to the nearest 0.1 g. Subtract this dry washed weight from the initial dry weight (Step 3) to obtain the weight loss by washing.
6. Pour entire sample into the nest of required sieves. Check each sieve carefully each day to make sure the sieve cloth is not damaged.
7. Shake sieves for a minimum of 7 minutes.
8. Weigh and record the amount retained on each individual sieve to the nearest 0.1 g. Total the amount retained on each sieve, the amount passing the 75 μm (No.200), and the loss by washing amount. This number must check to within $\pm 0.3\%$ of the initial dry weight of sample.
9. Calculate and record the amount passing each sieve to the nearest 0.1 g. The mass (weight) passing any sieve is the cumulative mass (weight) of all materials retained on each individual smaller sieve and the bottom.
10. Calculate and record the percent passing each sieve by dividing the amount passing each sieve by the check total mass (weight). Report percentages to the nearest whole number. Refer to Figure A 5-694.720.

Example :

Amount passing 600 μm (No.30) sieve = 207.2g

Check Total = 509.9 g

$$\% \text{ Passing } 600 \mu\text{m (No.30) sieve} = \frac{207.2 \text{ g}}{509.9\text{g}} = 41\%$$

11. Calculate the Fineness Modulus (F.M.). Add % Passing 9.5 mm, 4.75 mm, 2.36 mm, 1.18 mm, 600 μm , 300 μm , and 150 μm (3/8 in., No. 4, 8, 16, 30, 50, and 100) sieves, divide by 100 and subtract from 7. Report the fineness modulus to the nearest 0.01.

Refer to Figure A 5-694.720.

Example :

$$\text{F.M.} = 7 - \left((100 + 100 + 91 + 70 + 41 + 12 + 2) \div 100 \right)$$

$$\text{F.M.} = 7 - 4.16 = 2.84$$

5-694.150 INSPECTION OF WATER (Specification 3906)

Water used in mixing concrete shall not contain salt, oil, acid, injurious alkali, vegetable matter, or other deleterious substances. Generally, if the water is clear and palatable, it is satisfactory for use in concrete.

If the source of water that the Contractor intends to use appears questionable, take a 1 L (1 qt.) sample and send in to the Mn/DOT Office of Materials Laboratory for testing.

5-694.160 ADMIXTURES (Specification 3113)

A list of approved admixtures is available on the Mn/DOT Concrete Engineering Unit Website at www.mrr.dot.state.mn.us/pavement/concrete/products.asp.

5-694.170 APPROVED PRODUCTS

A list of approved products is available on the Mn/DOT Concrete Engineering Unit Website at www.mrr.dot.state.mn.us/pavement/concrete/products.asp.